

特選!

# でんぱなぎ

## デラックス Vol.7

# プレゼント 問題の解答

Q1 答え

D 空を飛ぶ龍



Q2 答え

A リス



Q3 答え

B メリーゴーランド

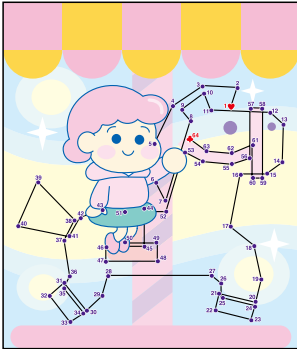

Q4 答え

B しやしほこ



Q5 答え

B バレエ



Q6 答え

C コイ

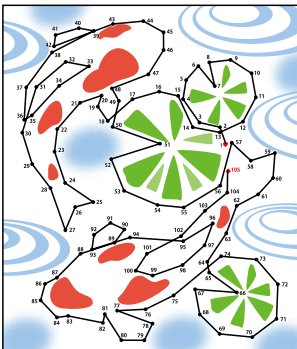

Q7 答え

B マンモス

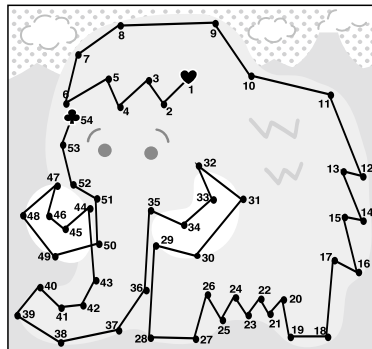

Q8 答え

C ジャンボすべり台

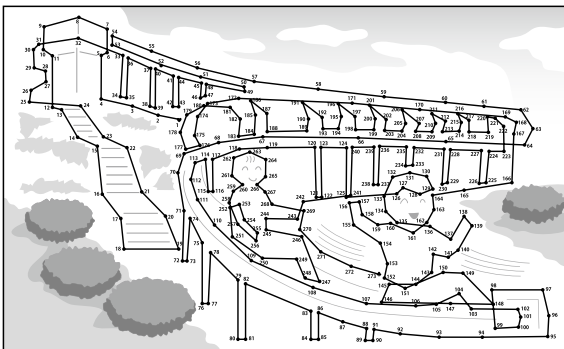

Q9 答え

A ゾウ

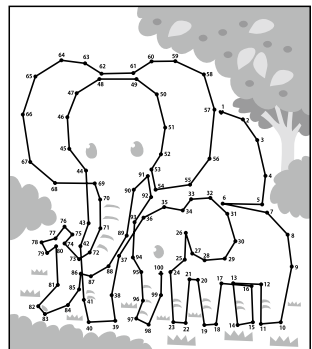

Q10 答え

A 宇宙人



Q11 答え

A カ士

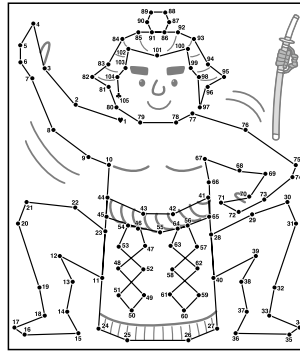

Q12 答え

A 花咲かじいさん

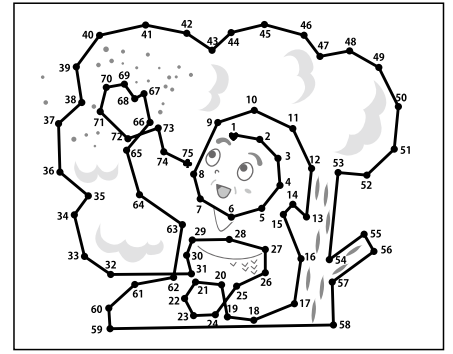

Q13 答え

C キツネ

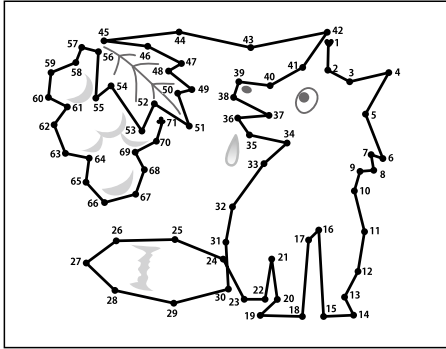

Q14 答え

A 瓦割り

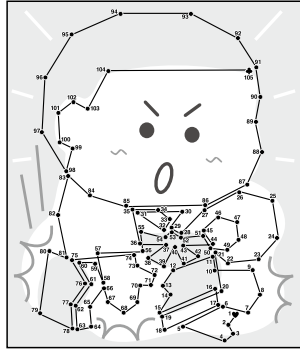

Q15 答え

A 1匹

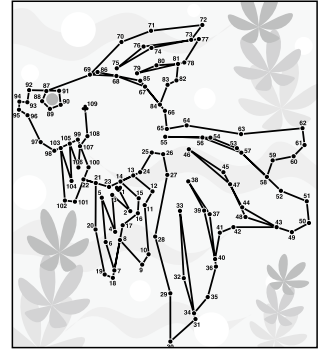

Q16 答え

B ロバ

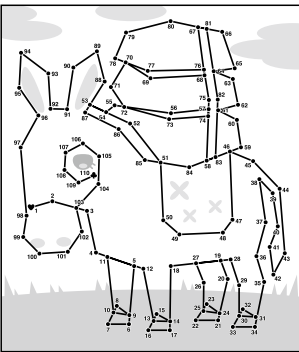

Q17 答え

C ループ

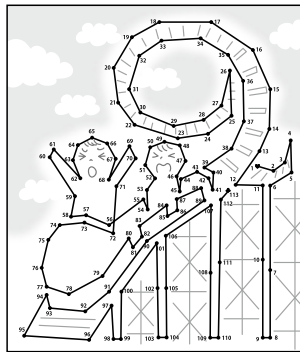

Q18 答え

A 飛行機

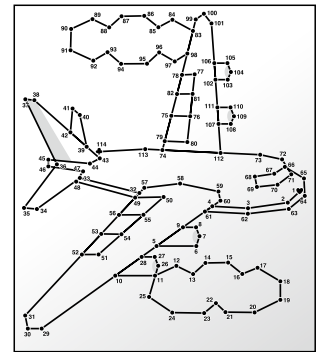

Q19 答え

C クラシックカー

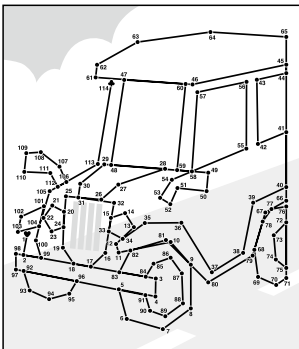

Q20 答え

B 逆上がり

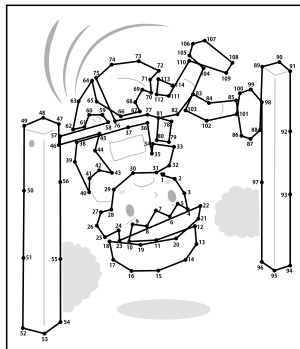

Q21 答え

A かぐや姫

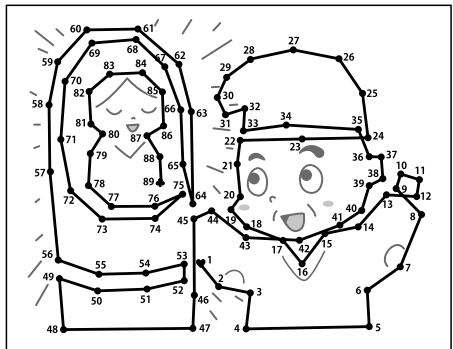

Q22 答え

C ピノキオ

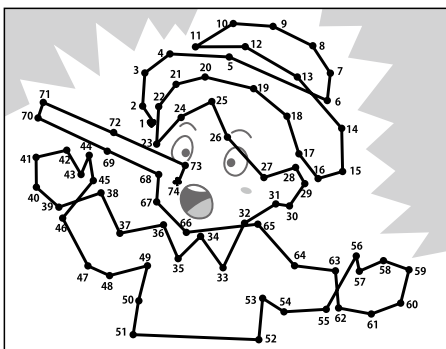

Q23 答え

C ガマガエル

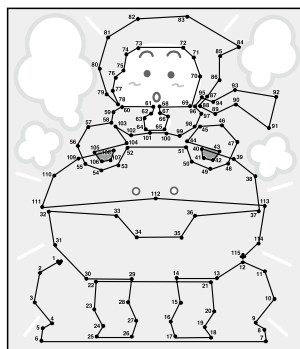

Q24 答え

B サル

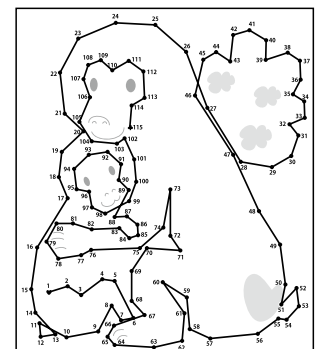

Q25 答え

C おでん

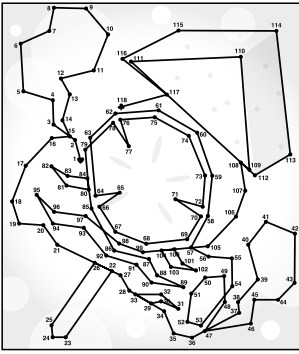

Q26 答え

A シンガポール

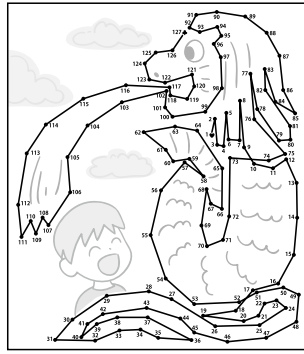

Q27 答え

C 鍵盤ハーモニカ

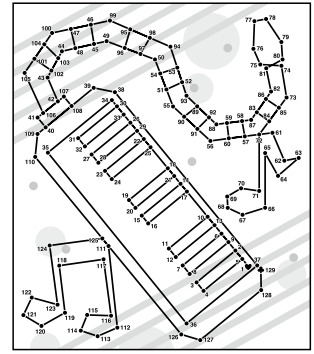

Q28 答え

C トランプ

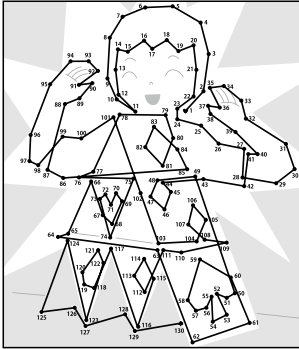

Q29 答え

C 都道府県の名前に含まれる

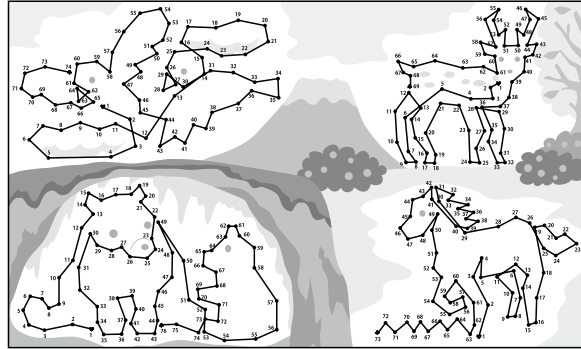

Q30 答え

B カエル

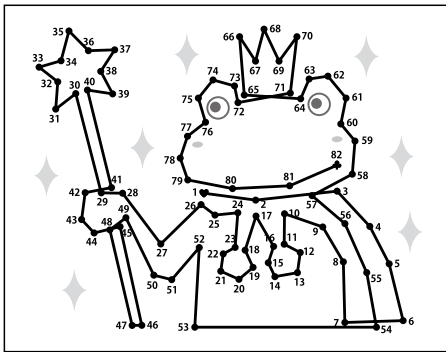

Q31 答え

C アリとキリギリス

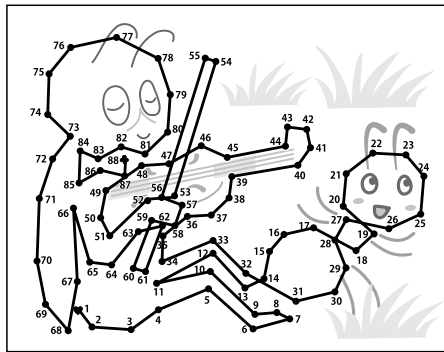

初級てんつき①

34 アイロン

Q32 答え

糸切りハサミ

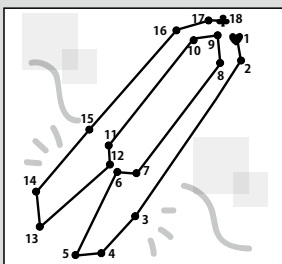

Q33 答え

ハンガー

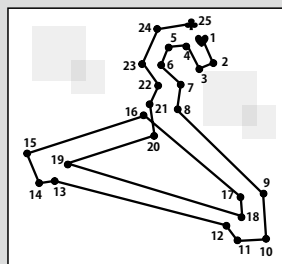

Q34 答え

アイロン

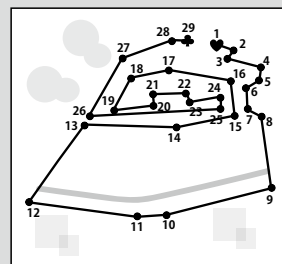

Q35 答え

ミシン

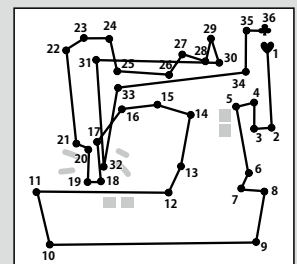

Q36 答え

A スケートボード

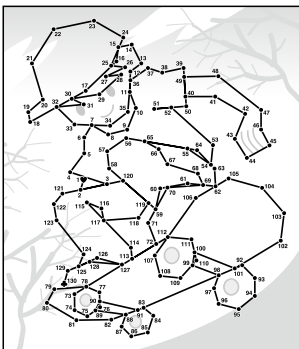

Q37 答え

A サーフィン

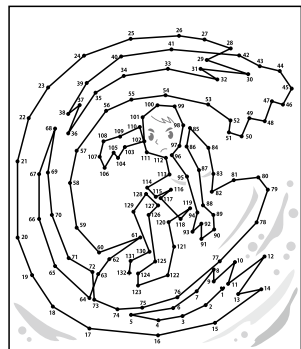

Q38 答え

B 雷様

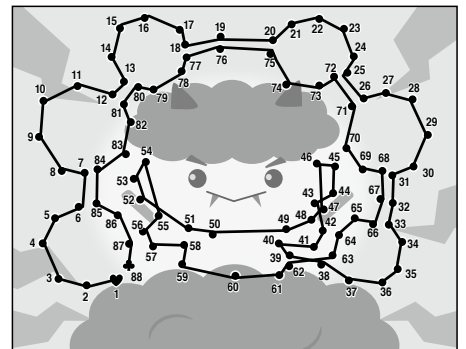

Q39 答え

A アシカ

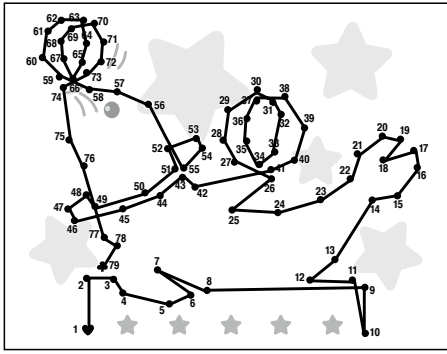

Q40 答え

B 抹茶

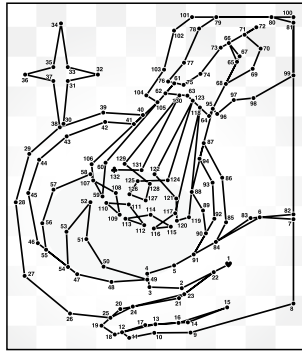

初級てんつき②

42 フクロウ

Q41 答え ツバメ

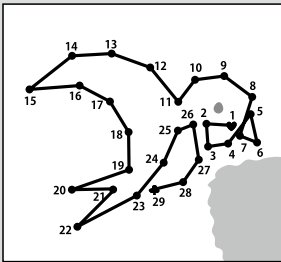

Q42 答え フクロウ

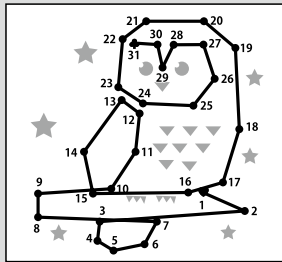

Q43 答え フラミンゴ

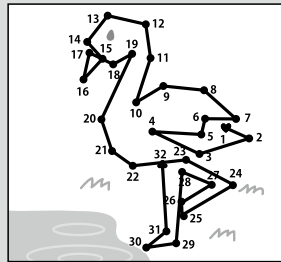

Q44 答え ダチョウ

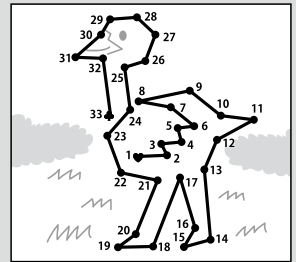

Q45 答え

A 雷門

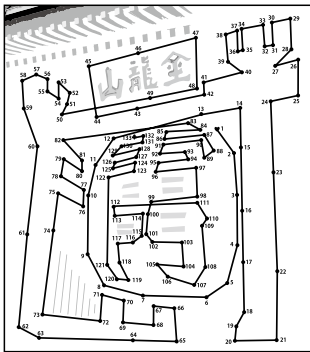

Q46 答え

B 長靴をはいた猫

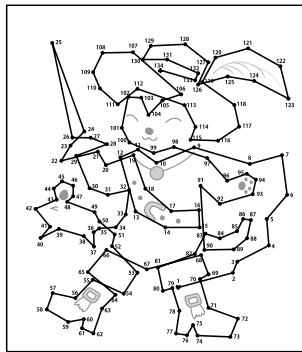

Q47 答え

C ハングライダー

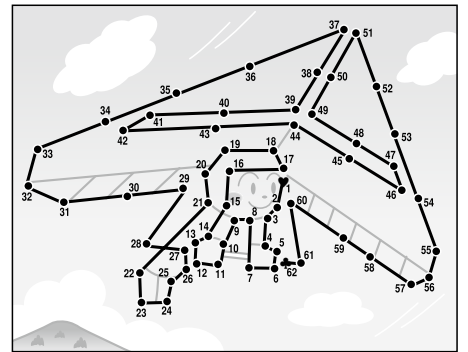

Q48 答え

A アリ

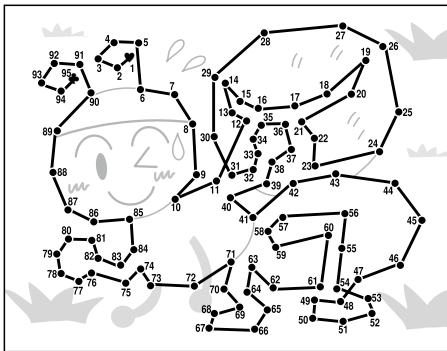

Q49 答え

A キュービッド



Q50 答え

B クマ

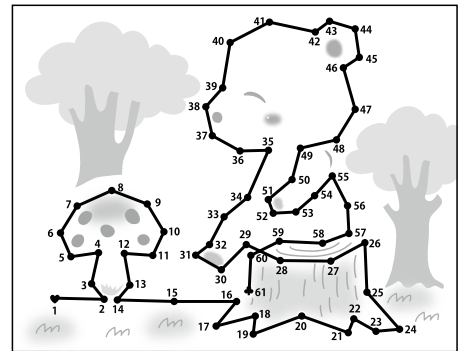

Q51 答え

C びっくり箱

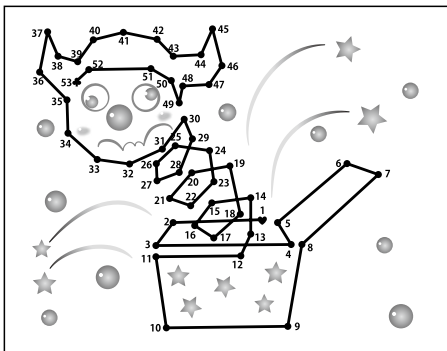

Q52 答え

B カエル

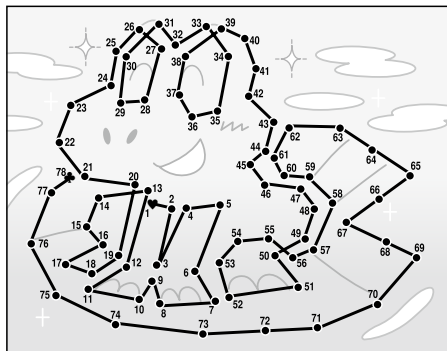

Q53 答え

C かたつむり

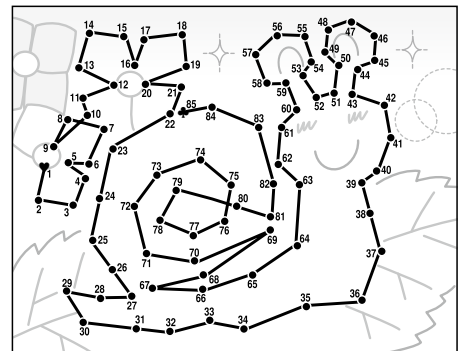

Q54 答え C ドライヤーで髪を乾かす

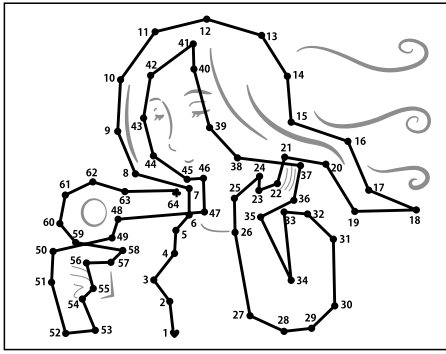

Q55 答え A 食事をとる

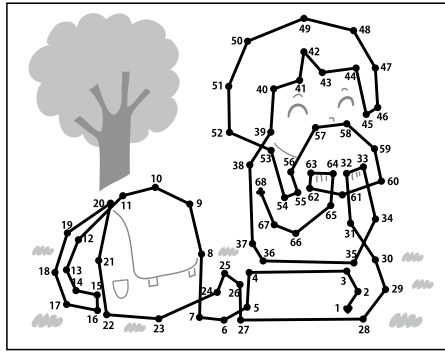

Q56 答え C 乙女座

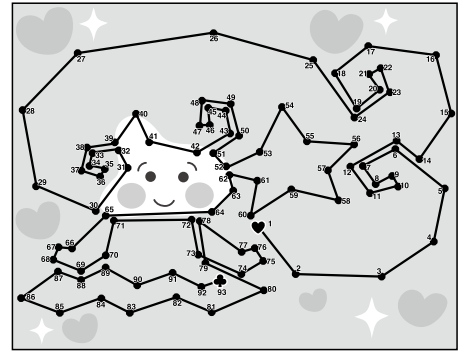

Q57 答え C 魚座

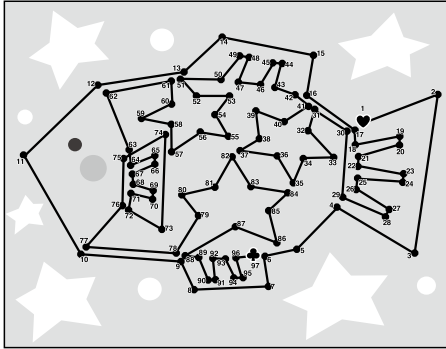

Q58 答え A セロハンテープ

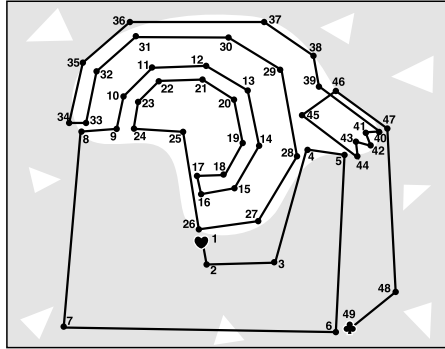

Q59 答え B ハサミ

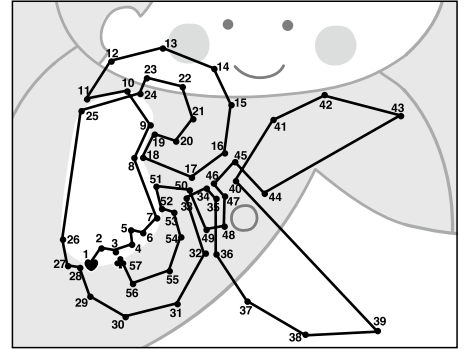

Q60 答え B ポストに投函

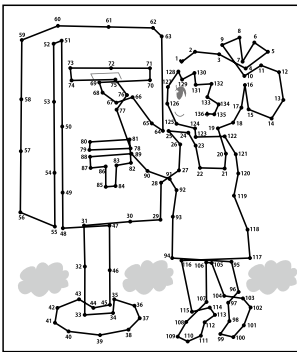

漢字てんつき①

C 三寒四温

Q61 答え 三

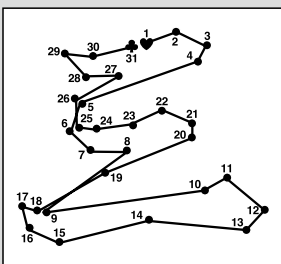

Q62 答え 四

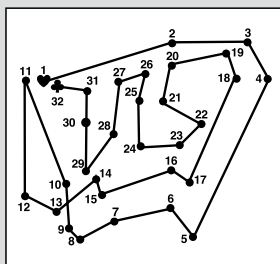

Q63 答え 寒

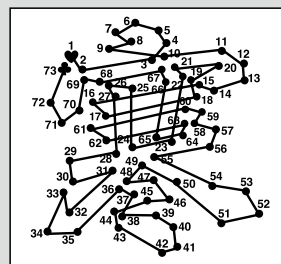

Q64 答え 温

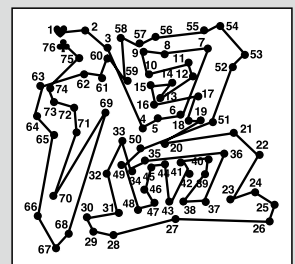

初級てんつき③

67 プリン

Q65 答え 目玉焼き

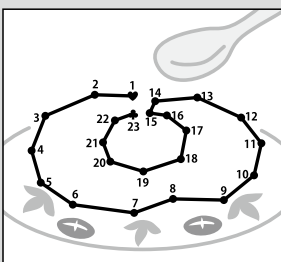

Q66 答え オムライス

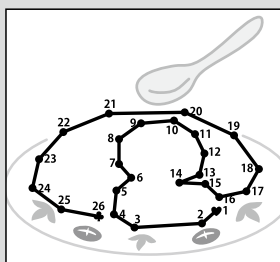

Q67 答え プリン

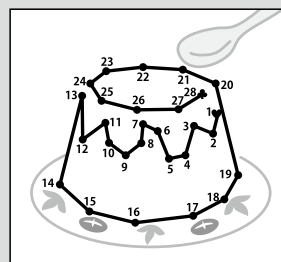

Q68 答え 茶碗蒸し

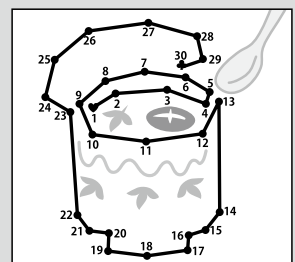

Q69 答え

A ピアノ

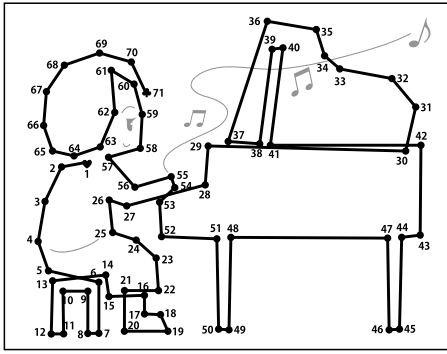

Q70 答え

B バイオリン

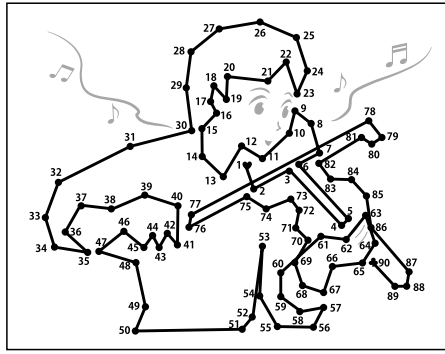

Q71 答え

C 旅行へ出発

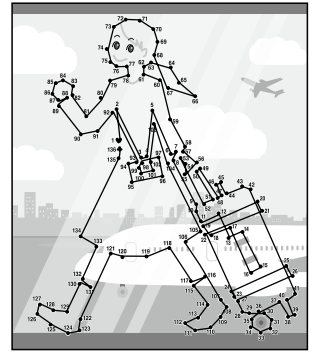

Q72 答え

B 狛犬

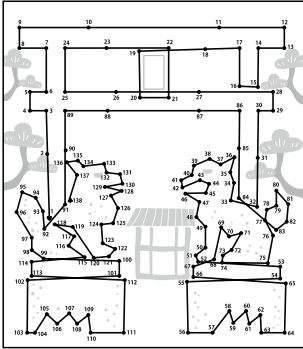

漢字てんつき②

A 一日千秋

Q73 答え 一

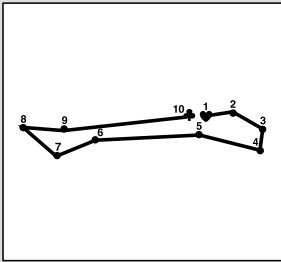

Q74 答え 日

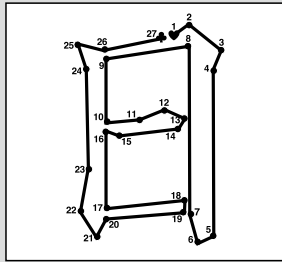

Q75 答え 干

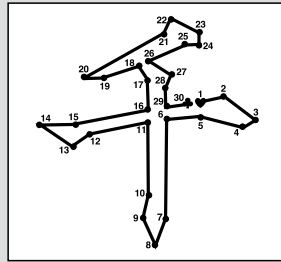

Q76 答え 秋

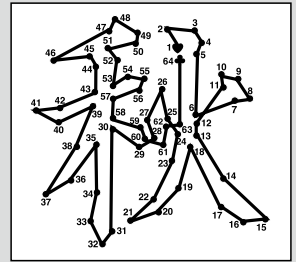

初級てんつき④

80 木彫りの熊

Q77 答え こけし

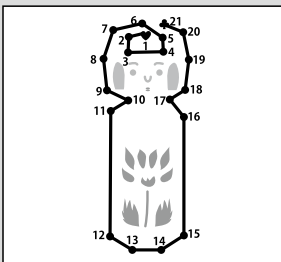

Q78 答え 扇

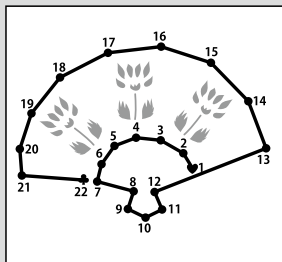

Q79 答え サルボボ

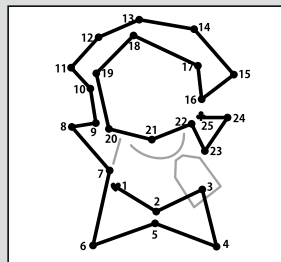

Q80 答え 木彫りの熊

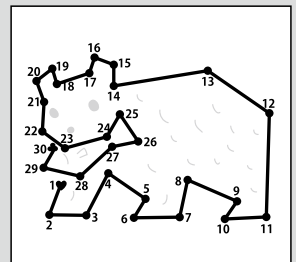

Q81 答え

A ハムスター

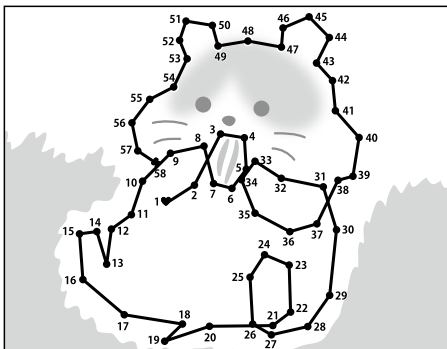

Q82 答え

B 線香花火

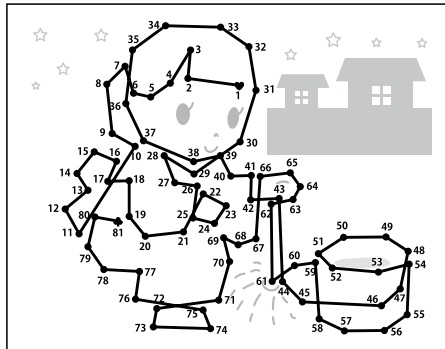

Q83 答え

B ヤギ

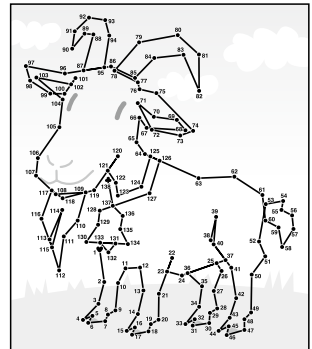

Q84 答え

D 雪だるま

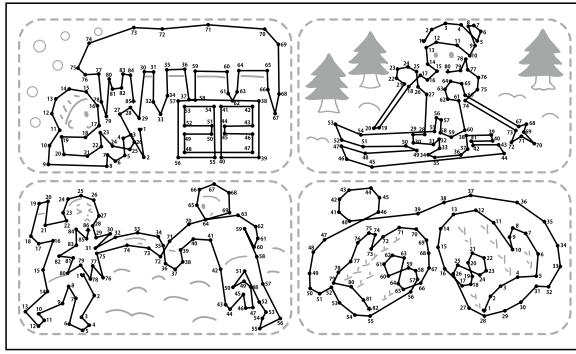

初級てんつなぎ⑤

88 鬼

Q85 答え きつね

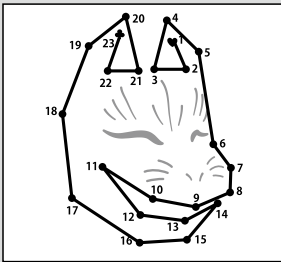

Q86 答え おかめ

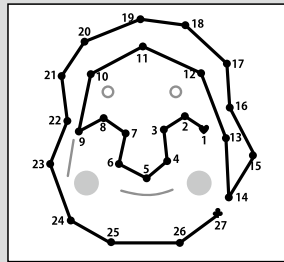

Q87 答え ひよっとこ

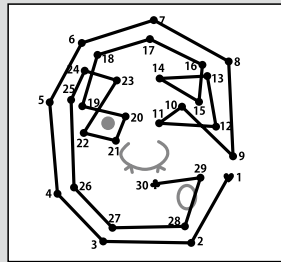

Q88 答え 鬼

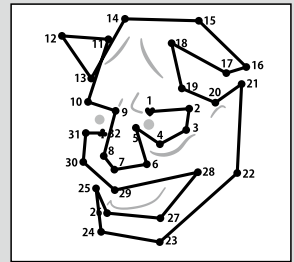

Q89 答え C 飛脚

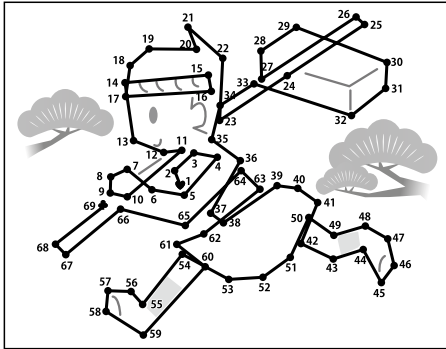

Q90 答え A パフ

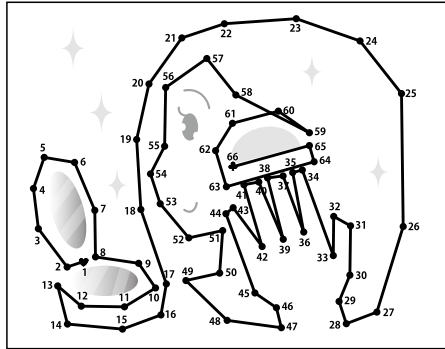

Q91 答え C 花びん

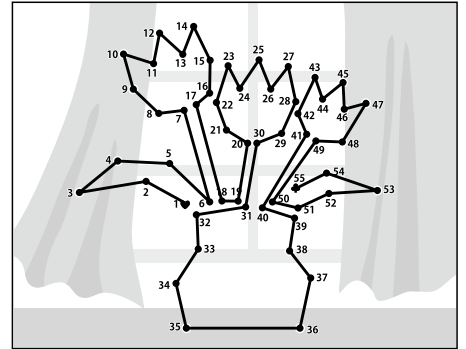

Q92 答え C 蓄音機

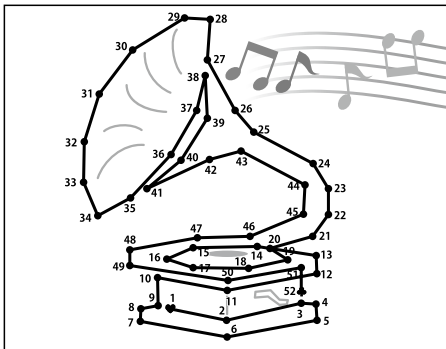

初級てんつなぎ⑥

96 バウムクーヘン

Q93 答え たいやき

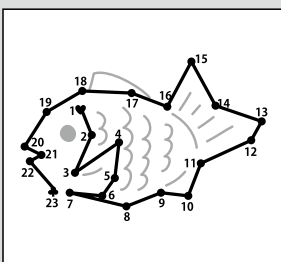

Q94 答え もみじ饅頭

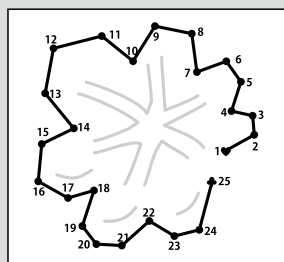

Q95 答え ハツ橋

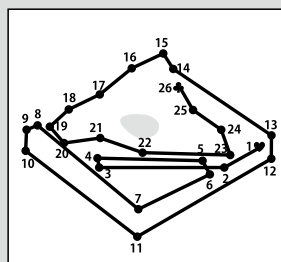

Q96 答え バウムクーヘン

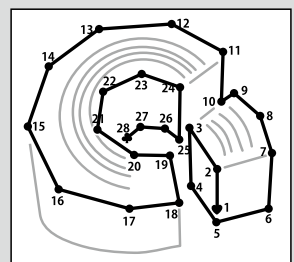

Q97 答え

C 雨に唄えば

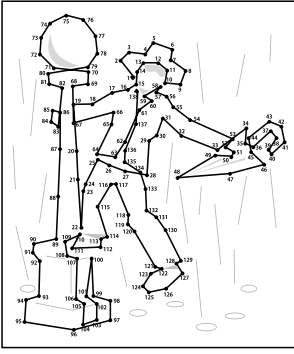

Q98 答え

B 王様

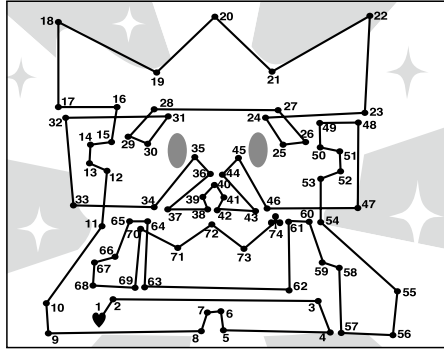

Q99 答え

A 天使

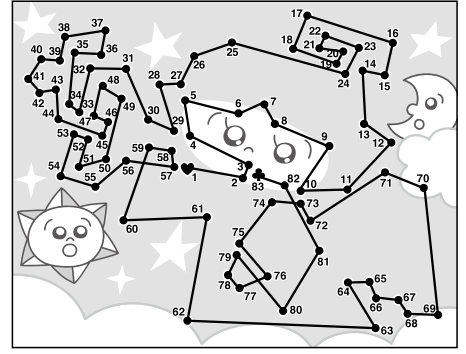

Q100 答え

C アイスクリーム

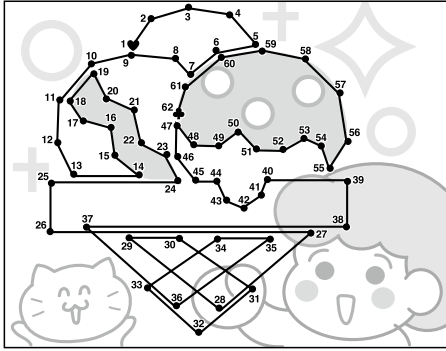

Q101 答え

B アライグマ

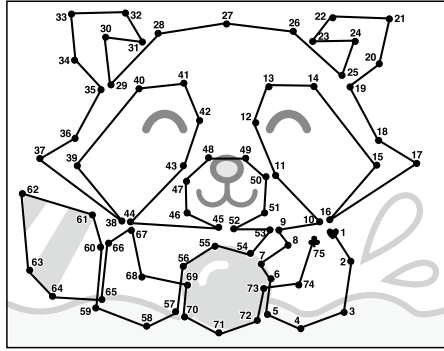

Q102 答え

B テニス

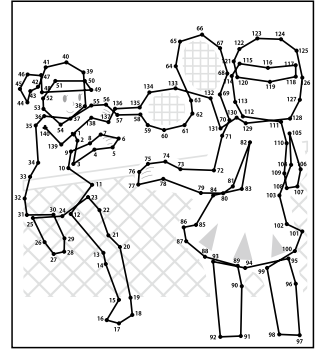

Q103 答え

C ウォーターコースター

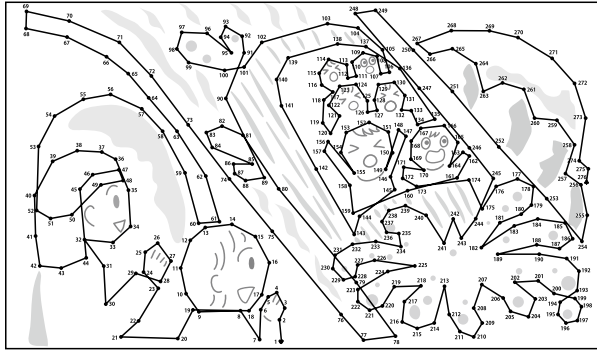

Q104 答え

A 一寸法師

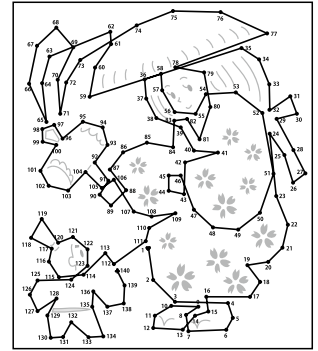

Q105 答え

A キツツキ

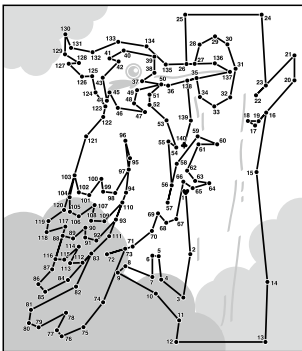

Q106 答え

A 恐竜

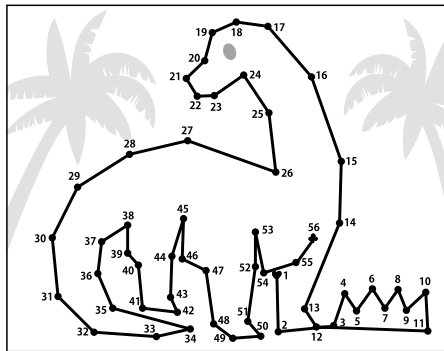

Q107 答え

C 羊

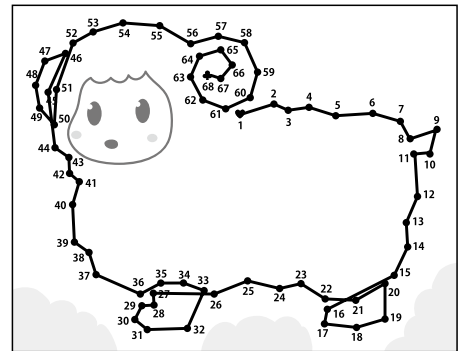

Q108 答え

B 腹話術

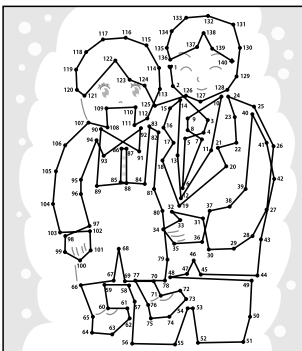



初級てんつなぎ⑦

112 キング

Q109 答え ルーク

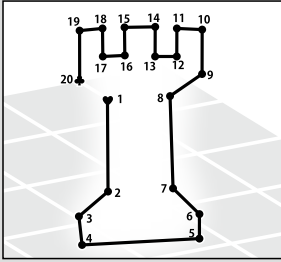

Q110 答え ポーン

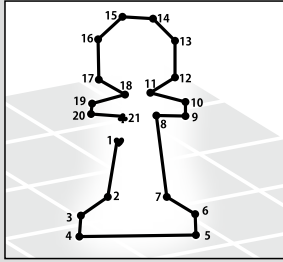

Q111 答え ナイト

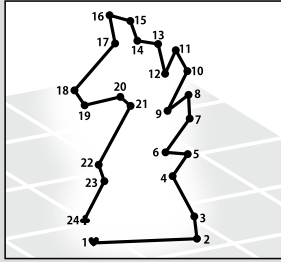

Q112 答え キング

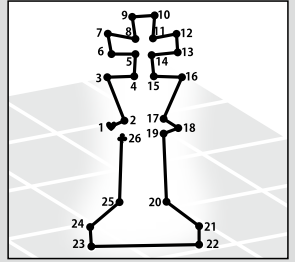

初級てんつなぎ⑧

113 若葉マーク

Q113 答え 若葉マーク

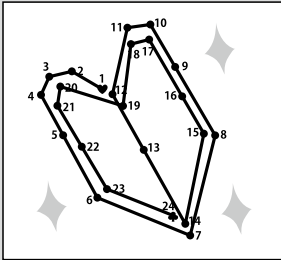

Q114 答え エコマーク

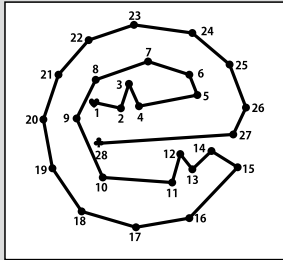

Q115 答え ベルマーク

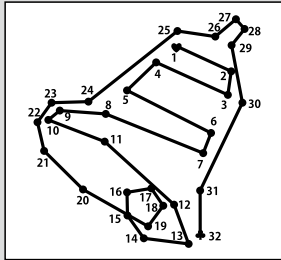

Q116 答え プラマーク

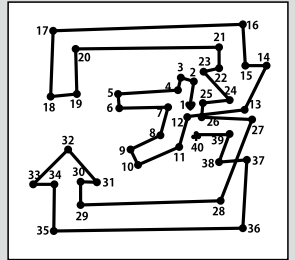

Q117 答え C 指揮者

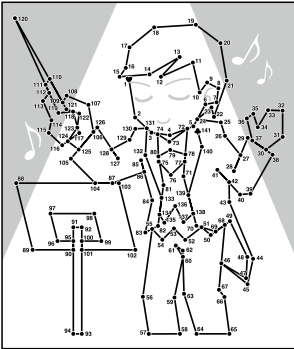

Q118 答え A クロール

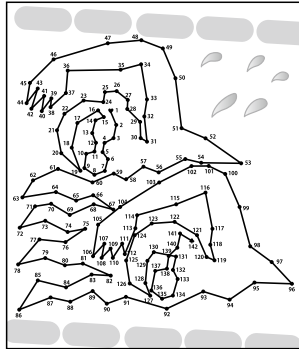

初級てんつなぎ⑨

119 ドーナツ

Q119 答え ドーナツ

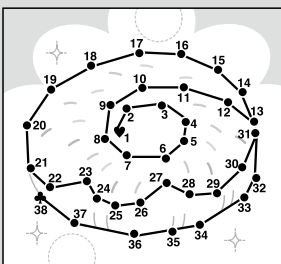

Q120 答え ホットケーキ

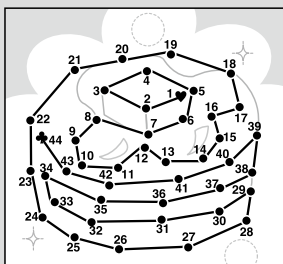

Q121 答え ショートケーキ

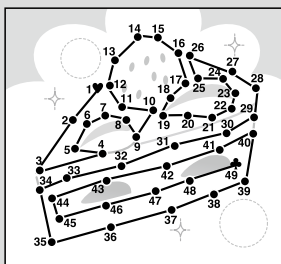

Q122 答え モンブラン

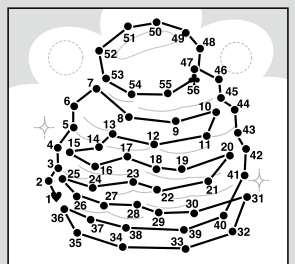

初級てんつなぎ⑩

124 万里の長城

Q123 答え スフィンクス

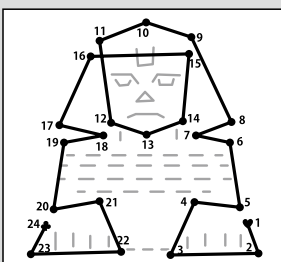

Q124 答え 万里の長城

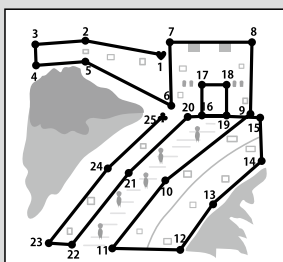

Q125 答え シドニー・オペラハウス

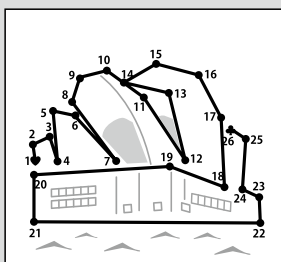

Q126 答え ピサの斜塔

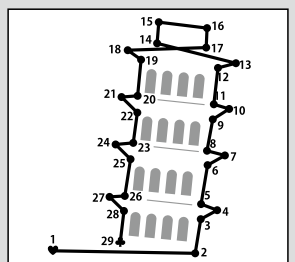

Q127 答え

A お弁当

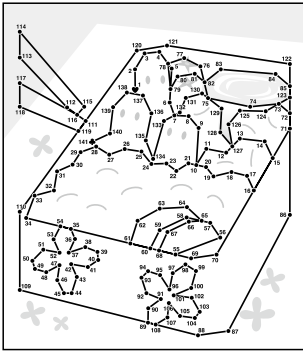

Q128 答え

B ぶんぶく茶釜

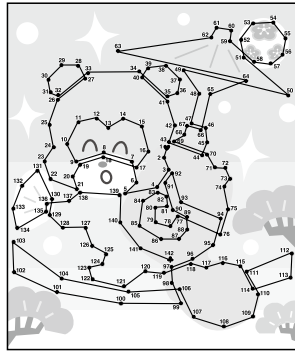

Q129 答え

A レーシングカー

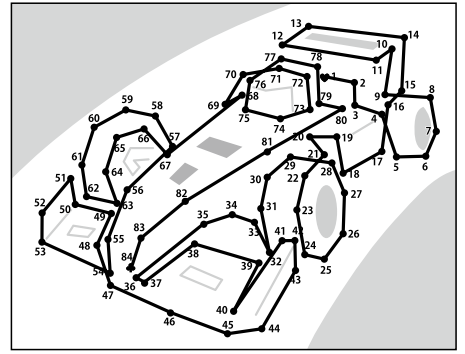

Q130 答え

C 三輪車

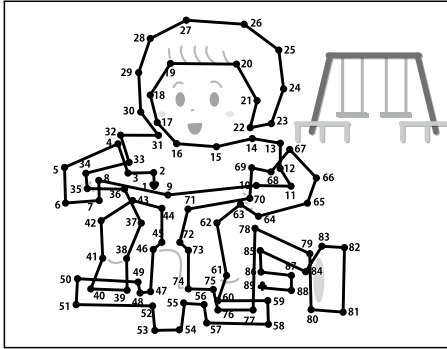

Q131 答え

A 観覧車

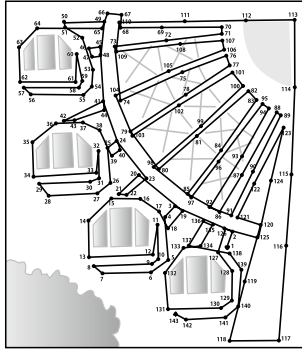

Q132 答え

A キツネ

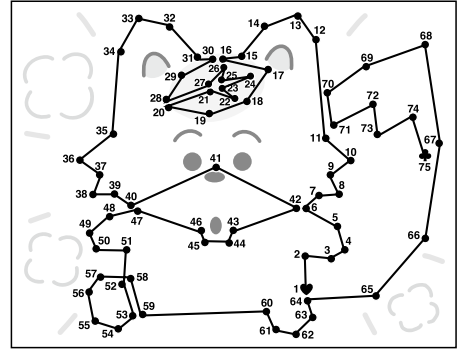

Q133 答え

B かぶと

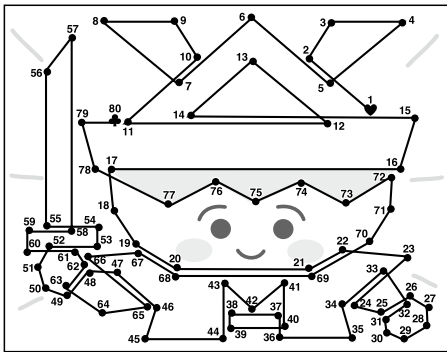

Q134 答え

C キャンプファイヤー

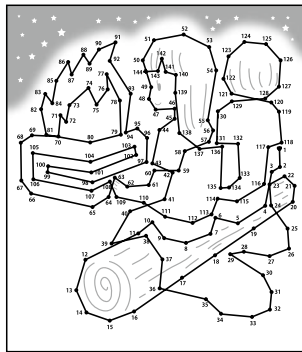

初級てんつき⑪

135 鉛筆と消しゴム

Q135 答え 鉛筆と消しゴム

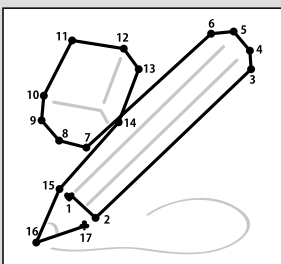

Q136 答え カッター

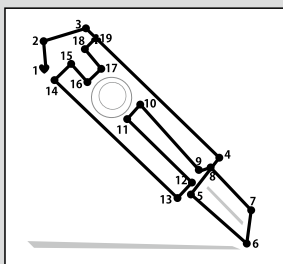

Q137 答え コンパス

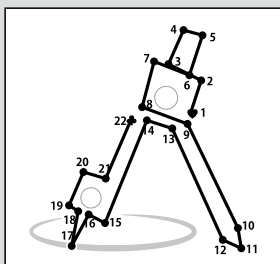

Q138 答え 鉛筆削り

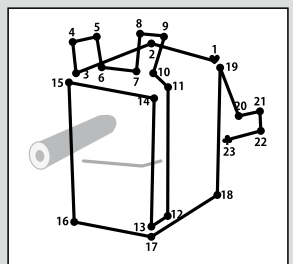

初級てんつき⑫

140 筏

Q139 答え ヨット

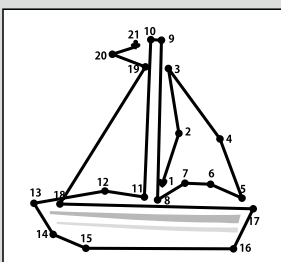

Q140 答え 筏

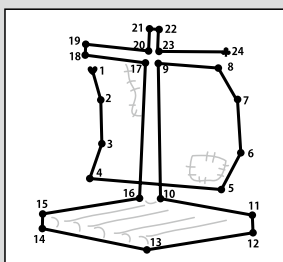

Q141 答え クルーズ客船

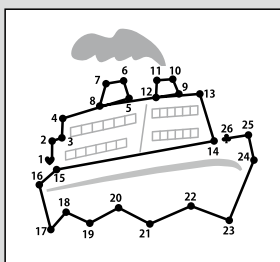

Q142 答え カヌー

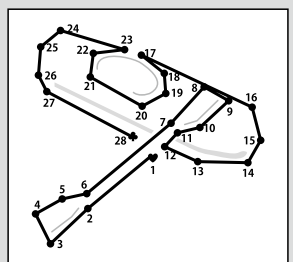

Q143 答え

C 田植え

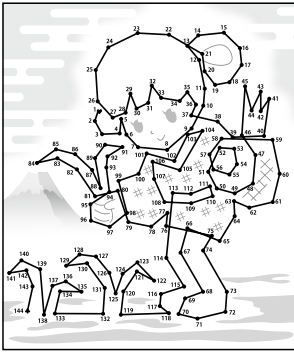

Q144 答え

D 結婚式

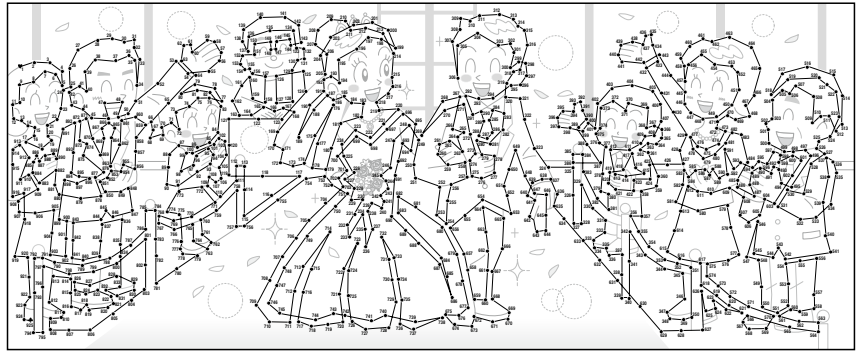

Q145 答え

E オーケストラ

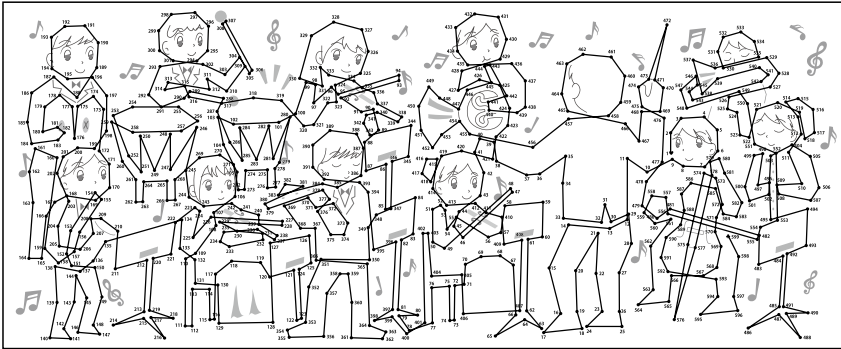

Q146 答え

C 鉄棒

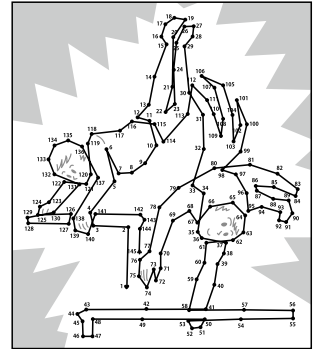

Q147 答え

B おきあがりこぼし

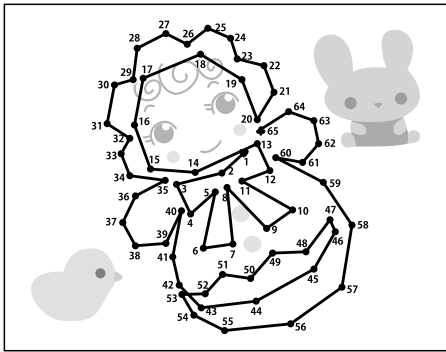

Q148 答え

A 木馬

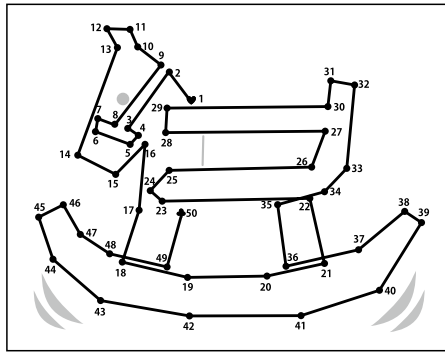

初級てんつなぎ⑬

151 カーディガン

Q149 答え

Tシャツ

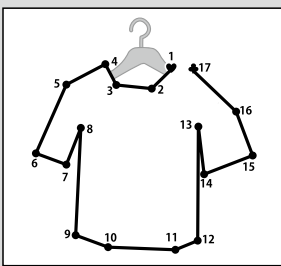

Q150 答え

タンクトップ

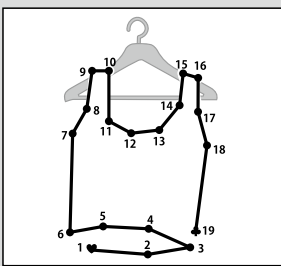

Q151 答え

カーディガン

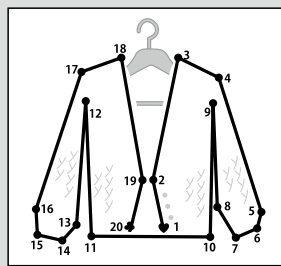

Q152 答え

Yシャツ

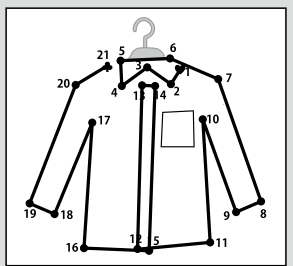

Q153 答え

B 電気スタンド

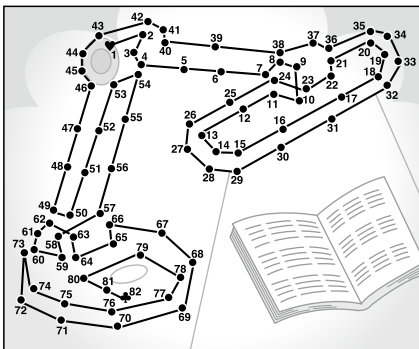

Q154 答え

A 掃除機

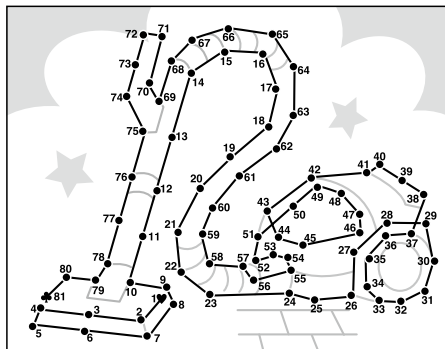

Q155 答え

B 柔道

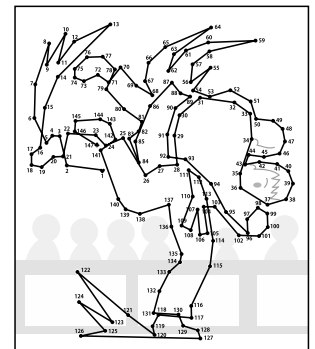

**Q156 答え** B 月世界旅行

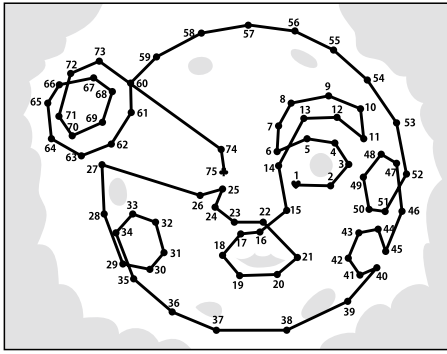

**Q157 答え** A マリリン・モンロー

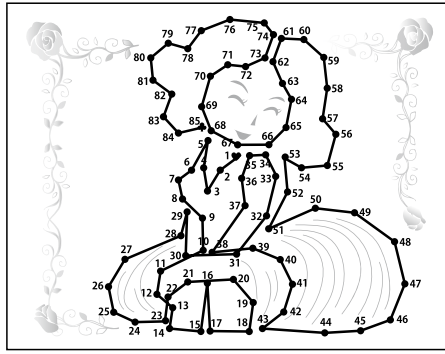

**Q158 答え** B 電気ケトル

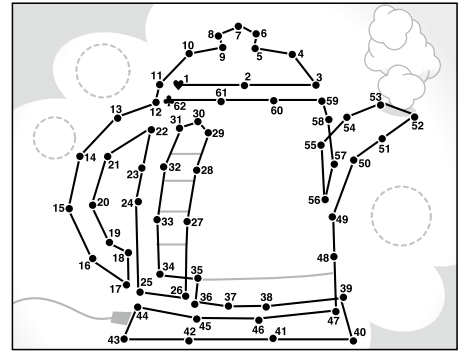

**Q159 答え** C タツノオトシゴ

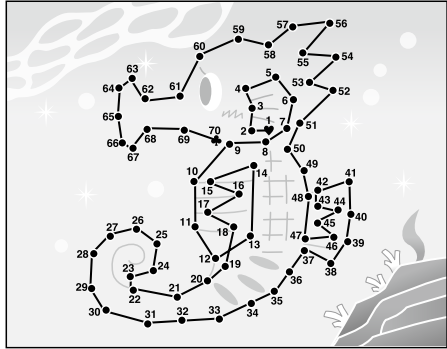

**Q160 答え** B ヤドカリ

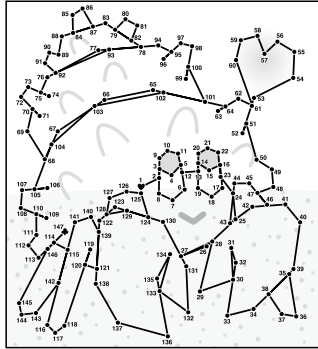

**Q161 答え** A さるかに合戦

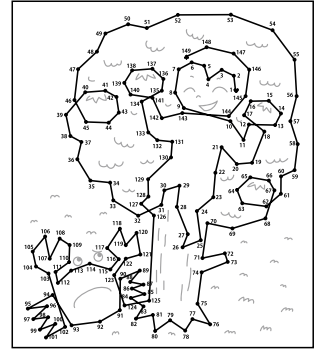

**初級てんつなぎ⑭**

**162 紙飛行機**

**Q162 答え** 紙飛行機

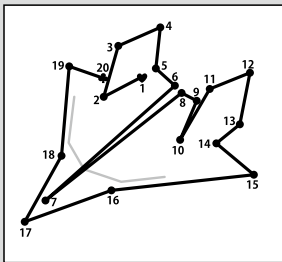

**Q163 答え** 折鶴

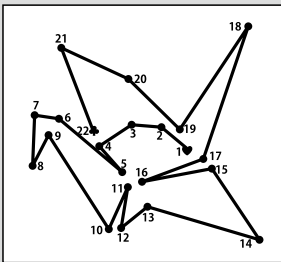

**Q164 答え** 風車

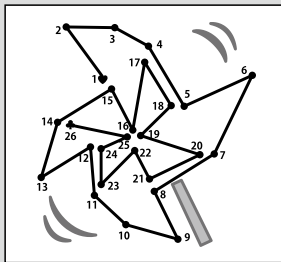

**Q165 答え** 紙相撲

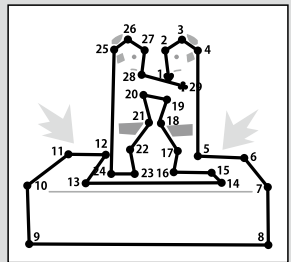

**Q166 答え** A お昼寝

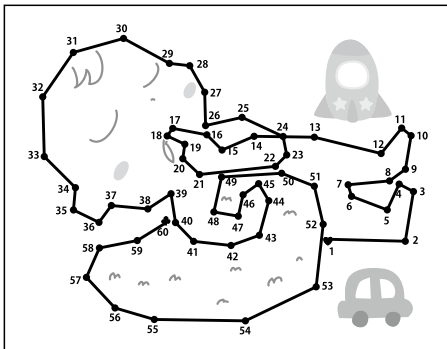

**Q167 答え** B 起きたところ

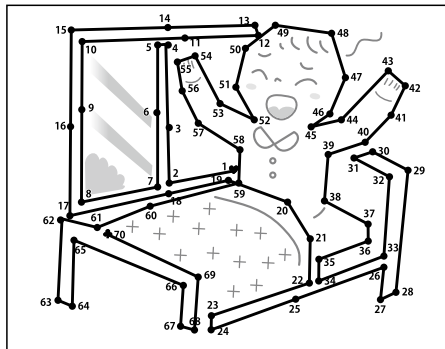

**Q168 答え** A 南京錠

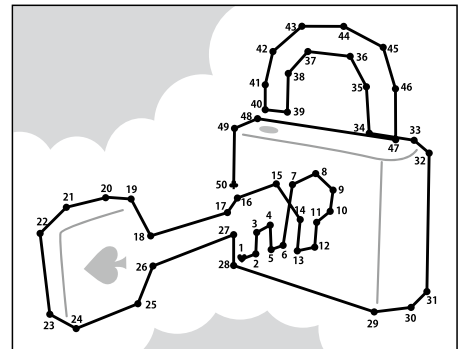

**Q169 答え** C ちょうちょ

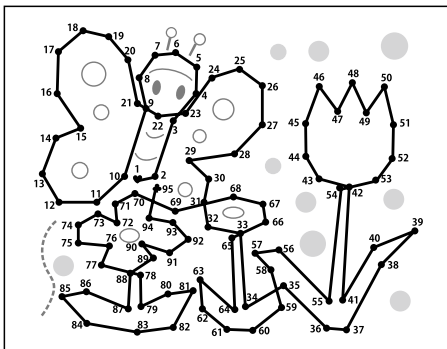

初級てんつなぎ<sup>15</sup>

173 メダル

Q170 答え 優勝カップ

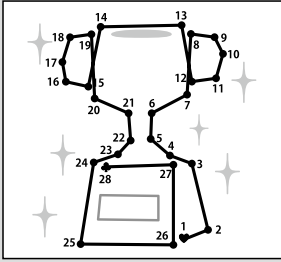

Q171 答え 優勝旗

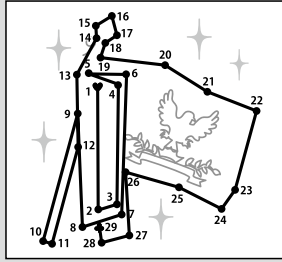

Q172 答え トロフィー

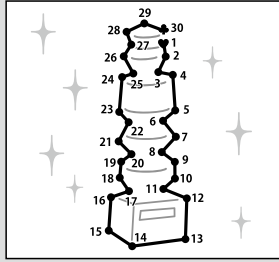

Q173 答え メダル

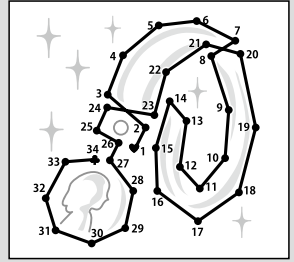

Q174 答え C ジグソーパズル

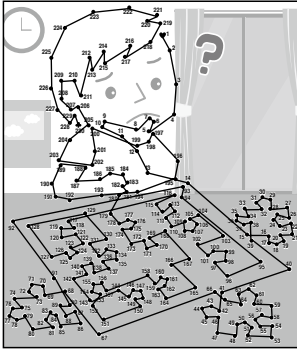

初級てんつなぎ<sup>16</sup>

175 ガラケー

Q175 答え ガラケー

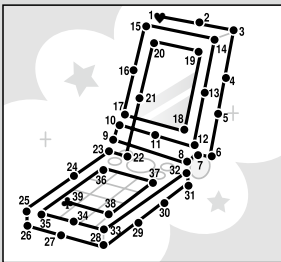

Q176 答え 黒電話

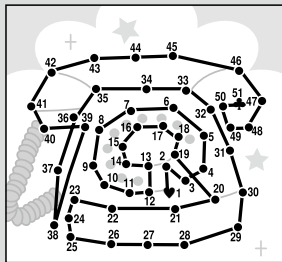

Q177 答え 公衆電話

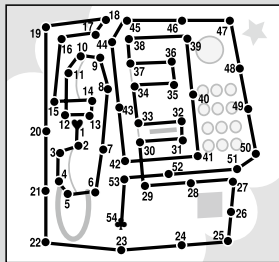

Q178 答え デルビル電話機

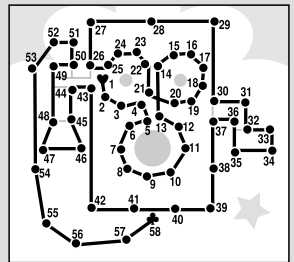

Q179 答え B ラジオ体操

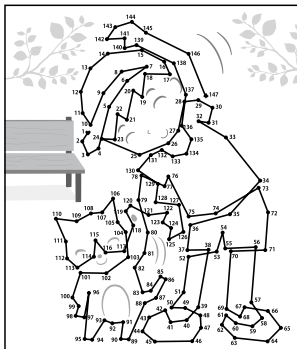

Q180 答え A チアガール

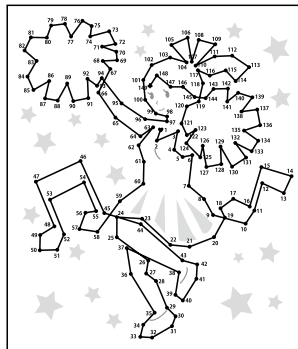

Q181 答え B ユニコーン

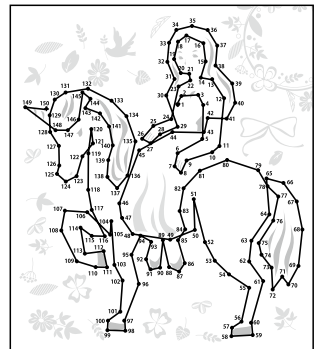

Q182 答え A ニワトリとヒヨコ

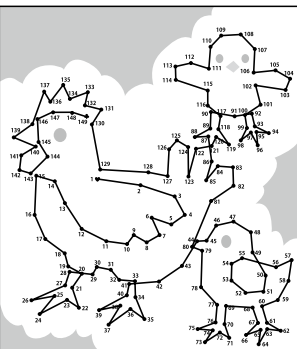

Q183 答え A 猫に小判

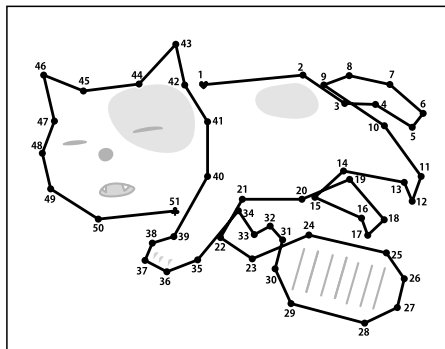

Q184 答え B 丸太を切る

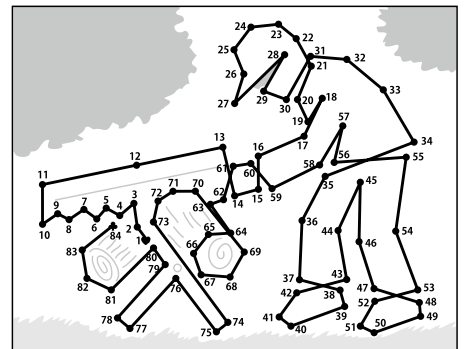

Q185 答え 一

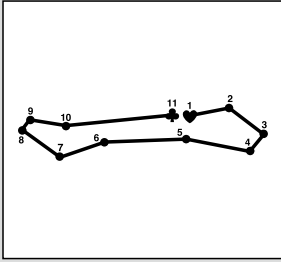

Q186 答え 千

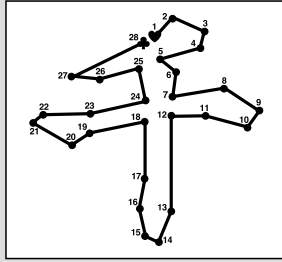

Q187 答え 当

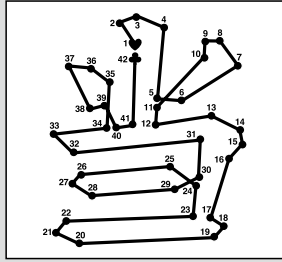

Q188 答え 騎

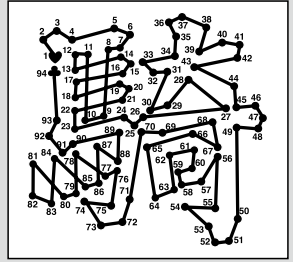

Q189 答え

C 新幹線

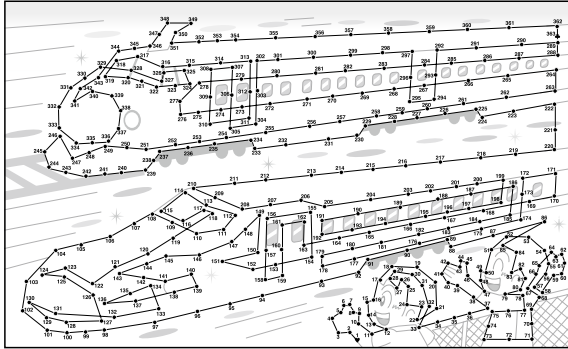

Q190 答え

A フラダンス

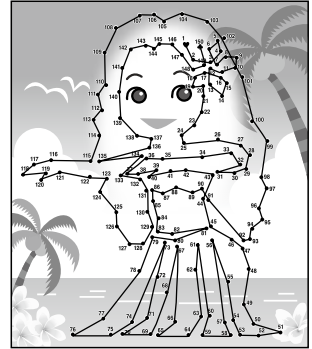

Q191 答え

B シンデレラ

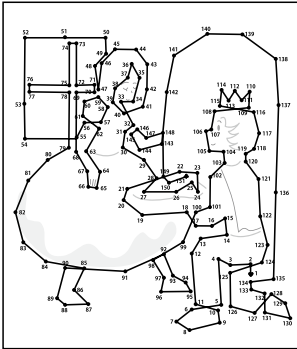

Q192 答え

C お地蔵さま

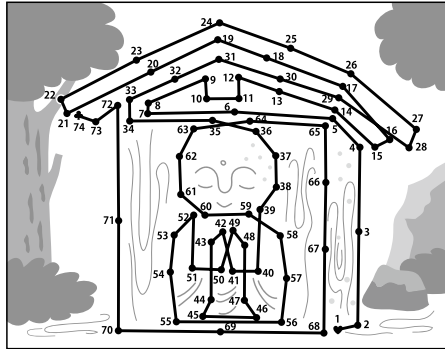

Q193 答え

C 四つ葉のクローバー

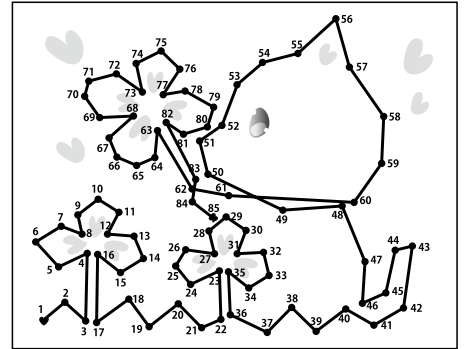

Q194 答え

B 提灯

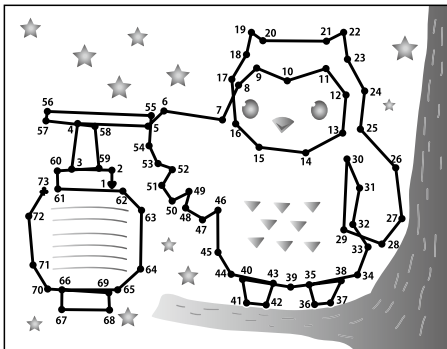

Q195 答え

A 秘書

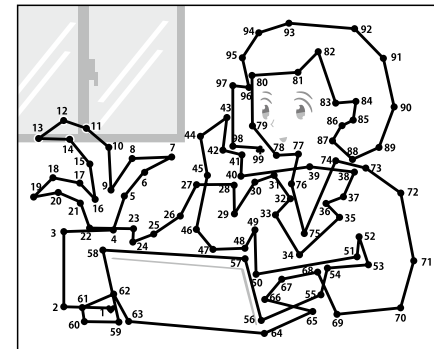

Q196 答え

B 風船

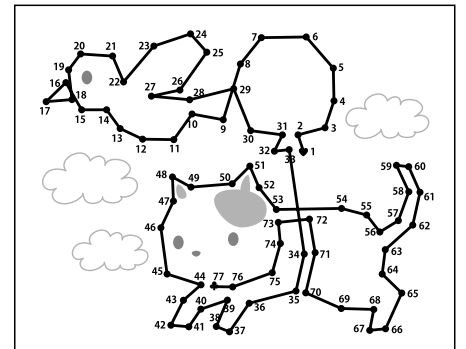

Q197 答え

C 窓を開ける

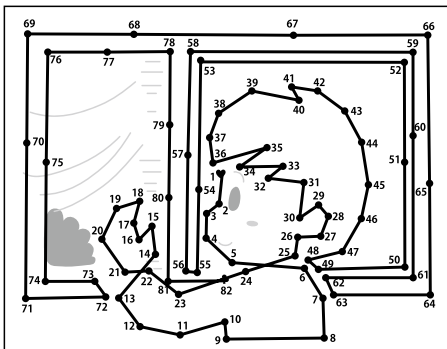

Q198 答え

C ウマ

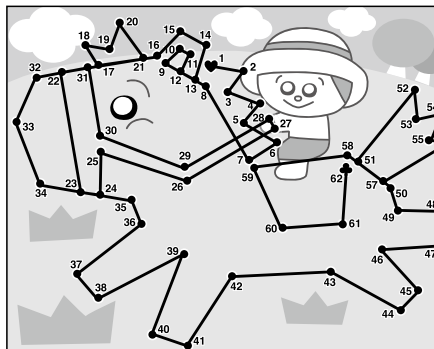

Q199 答え

B ゴリラ

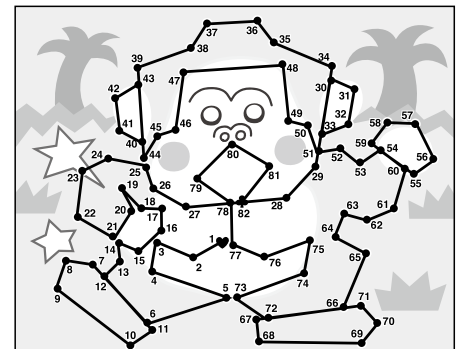

**Q200 答え** A タージ・マハル

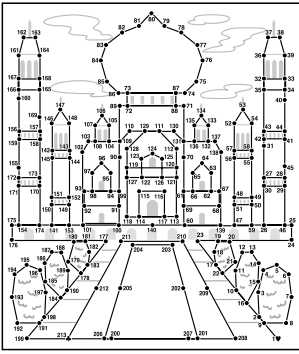

**漢字てんつなぎ④**

**B 不言実行**

**Q201 答え** 不

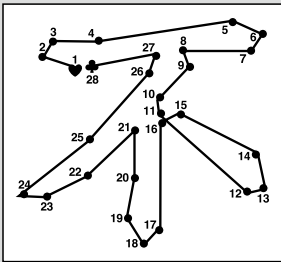

**Q202 答え** 行

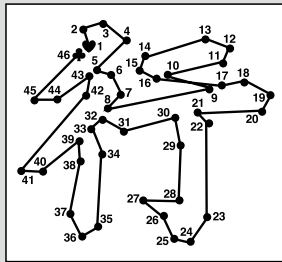

**Q203 答え** 言

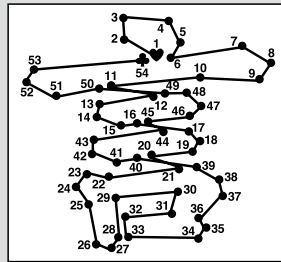

**Q204 答え** 実

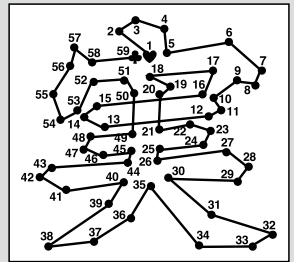

**Q205 答え** A オシドリ

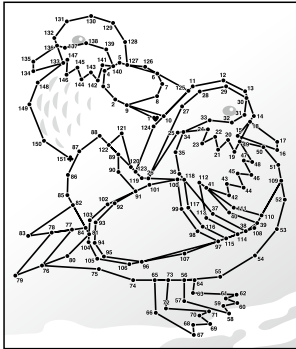

**Q206 答え** B ワニ

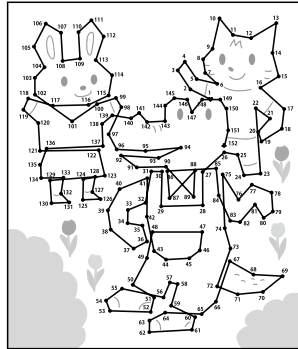

**初級てんつなぎ⑰**

**207 ヨーヨー**

**Q207 答え** ヨーヨー

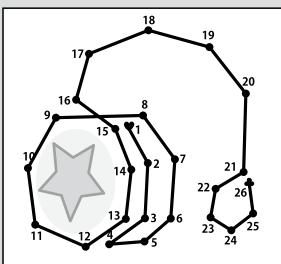

**Q208 答え** 凧

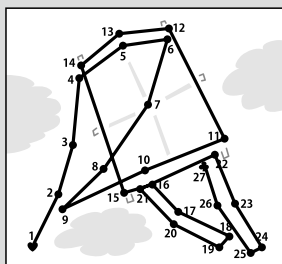

**Q209 答え** コマ

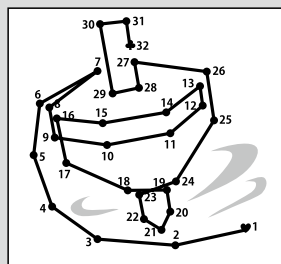

**Q210 答え** けん玉

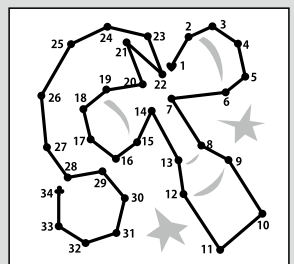

**Q211 答え** B カメレオン

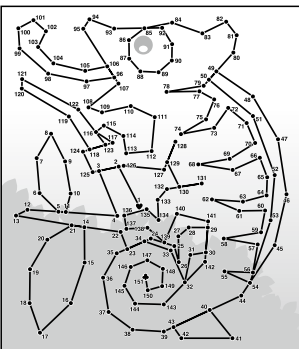

**Q212 答え** A スニーカー

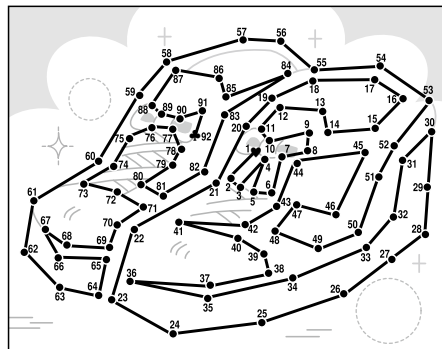

**Q213 答え** C ヘビ

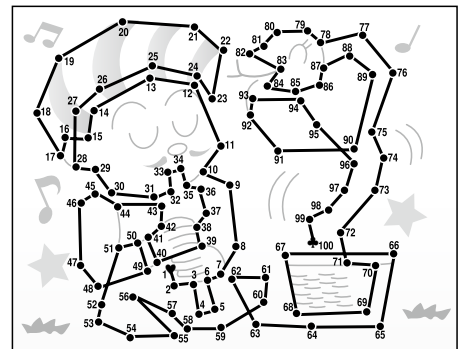

Q214 答え

C バイキング

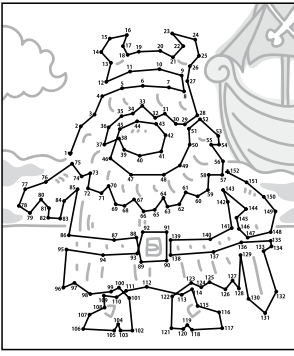

Q215 答え

C 神主さん

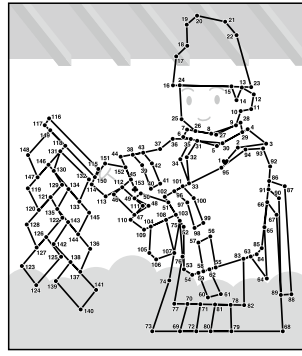

Q216 答え

A 虫取り

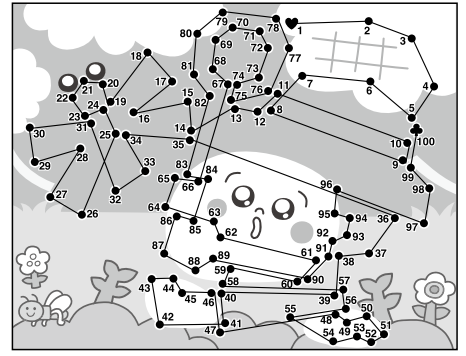

Q217 答え

B 蚊取り線香

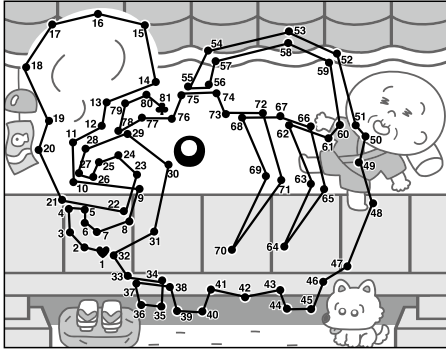

Q218 答え

C 白雪姫

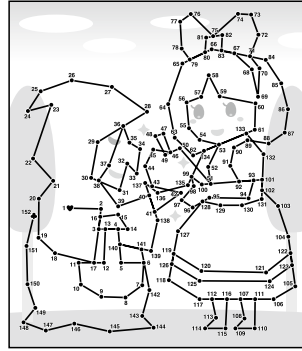

初級てんつき⑱

219 3の目

Q219 答え 3の目

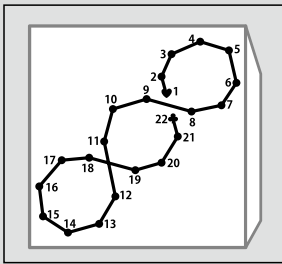

Q220 答え 6の目

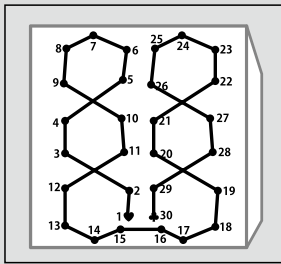

Q221 答え 5の目

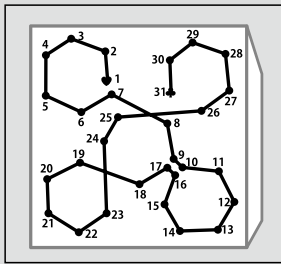

Q222 答え 4の目

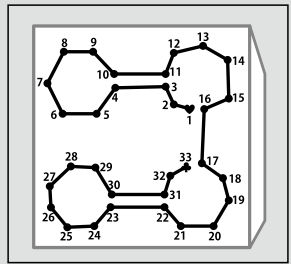

Q223 答え

B キングコング

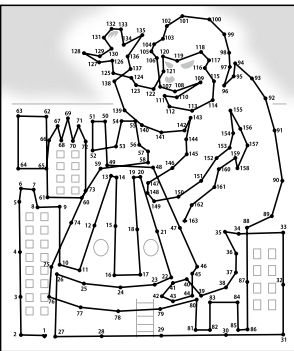

Q224 答え

C 空き缶

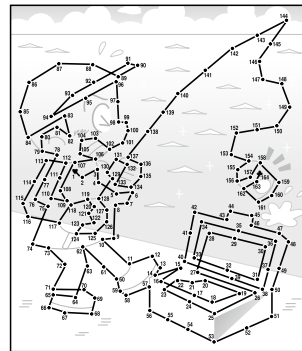

Q225 答え

A ピエロ

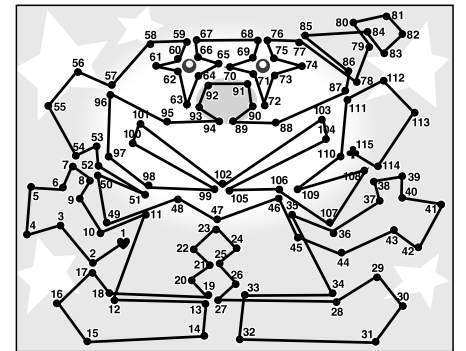

Q226 答え

B リス

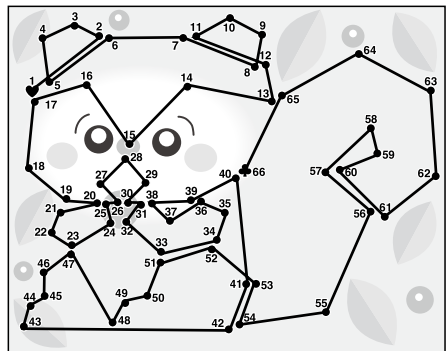

Q227 答え

A 華道

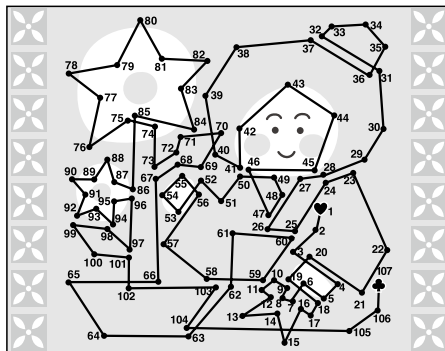

Q228 答え

C タンポポ

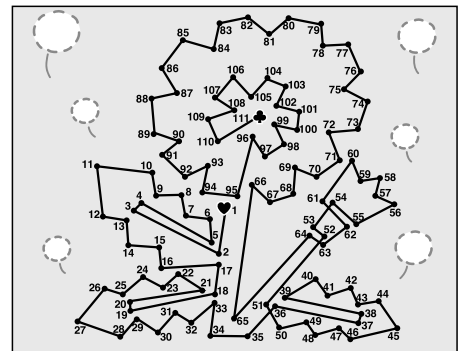



Q229 答え

C クジャク

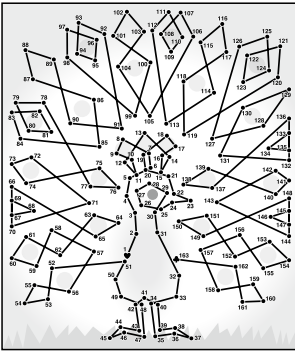

漢字てんつなぎ⑤

A 体力向上

Q230 答え 向

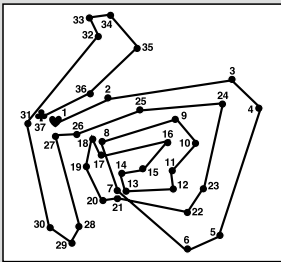

Q231 答え 体

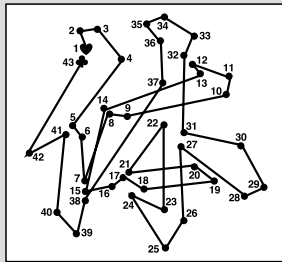

Q232 答え 上

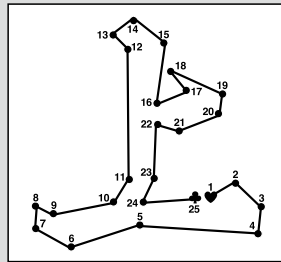

Q233 答え 力

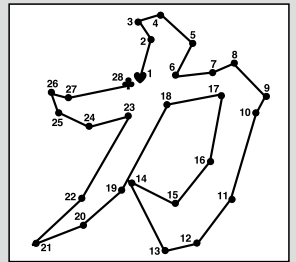

Q234 答え

A 国会議事堂

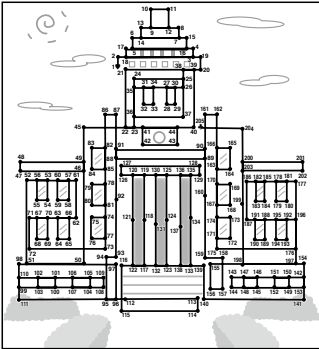

初級てんつなぎ⑱

238 韓国

Q235 答え ネパール

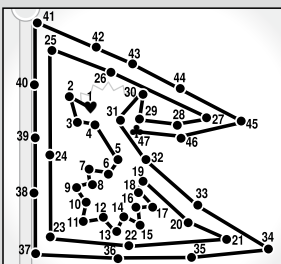

Q236 答え イギリス

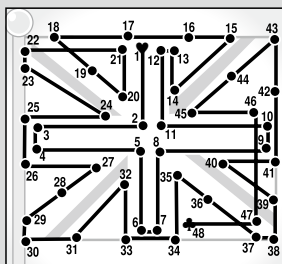

Q237 答え カナダ

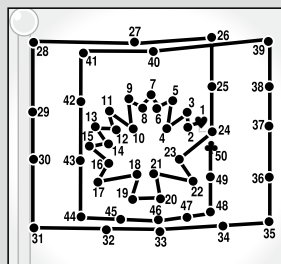

Q238 答え 韓国

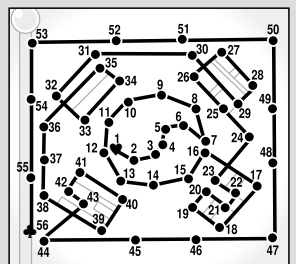

漢字てんつなぎ⑥

B 四書五経

Q239 答え 五

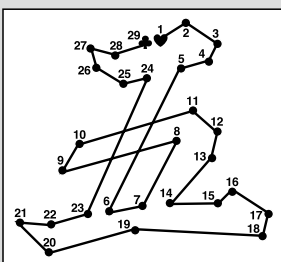

Q240 答え 四

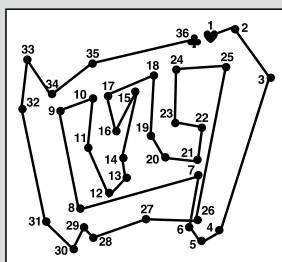

Q241 答え 書

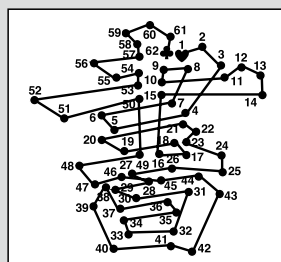

Q242 答え 経

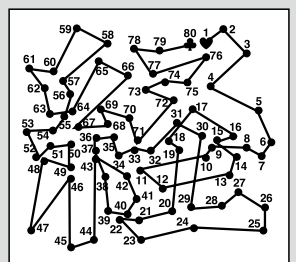

Q243 答え C てるてる坊主

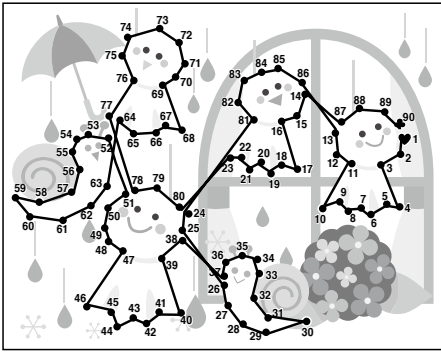

Q244 答え A イチゴ狩り

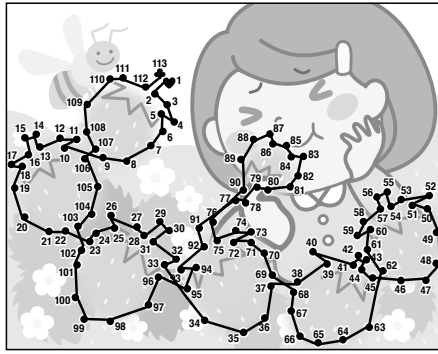

Q245 答え A 野球

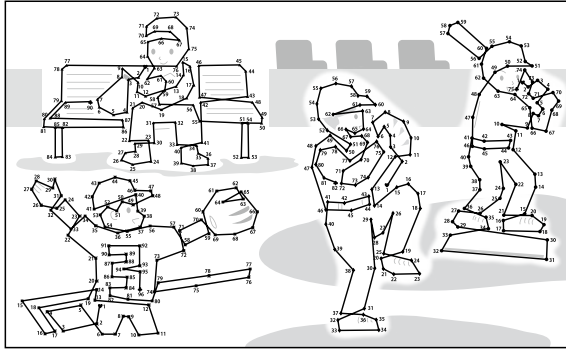

Q246 答え C カウボーイ

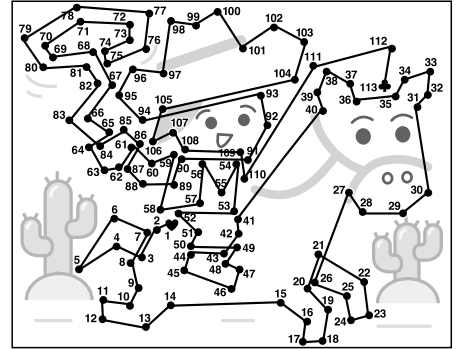

Q247 答え A 穴掘り

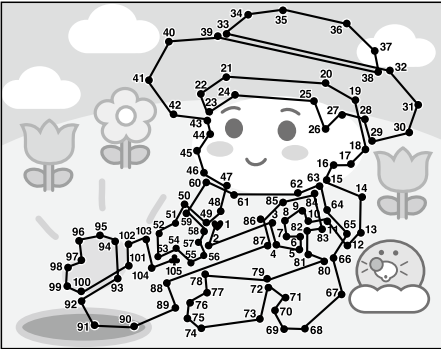

Q248 答え B ハンバーガー

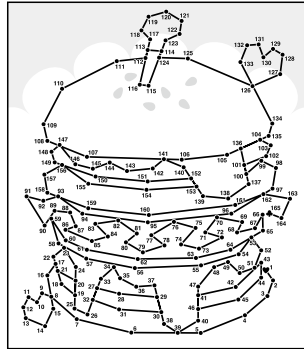

Q249 答え C カンガルー

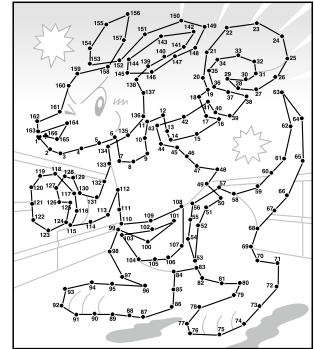

Q250 答え B かもめの水兵さん

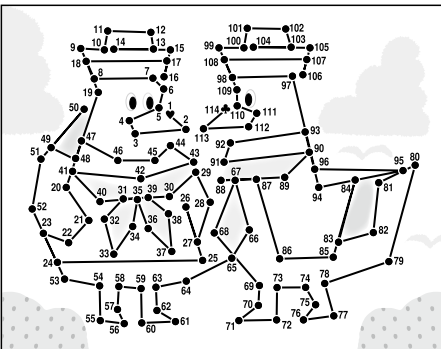

Q251 答え C 新割り

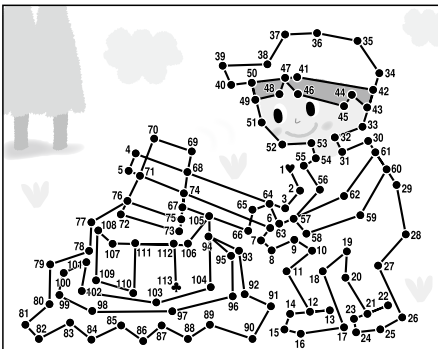

Q252 答え A 東洲斎写楽

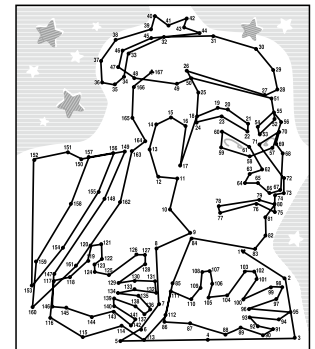

Q253 答え B カトムシとクワガタ

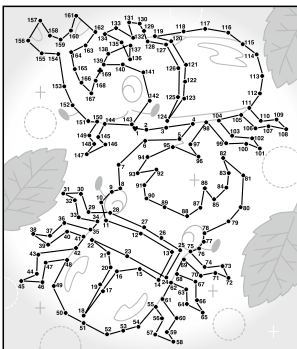

Q254 答え A 汽車

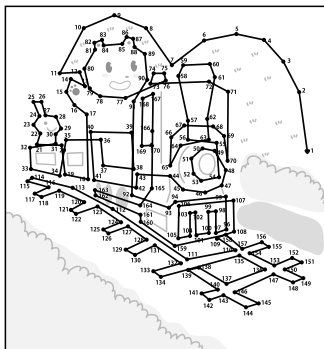

Q255 答え B 牛乳

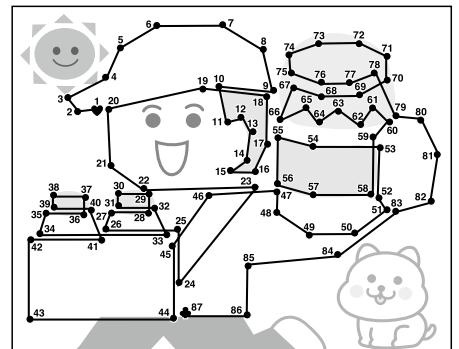

Q256 答え

A バーベキュー

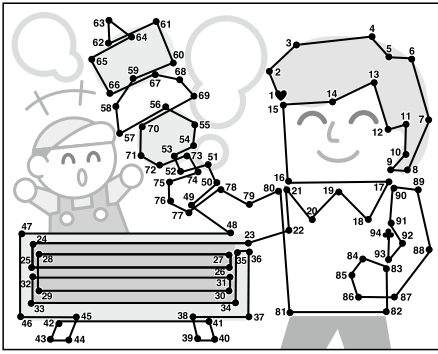

Q257 答え

C トイレトレーニング

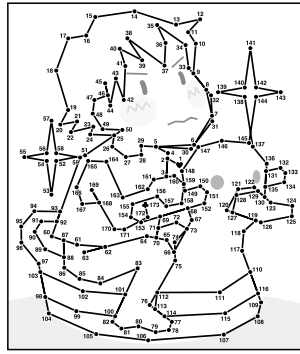

Q258 答え

B カーリング

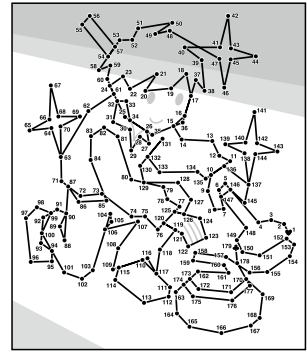

Q259 答え

C ヘンゼルとグレーテル

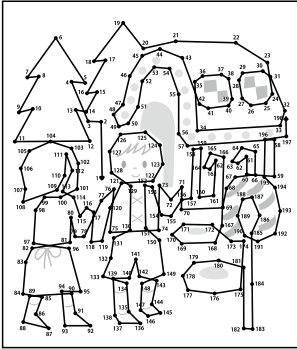

初級てんつなぎ⑩

262 ドライヤー

Q260 答え くし

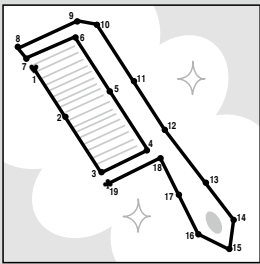

Q261 答え シャンプー

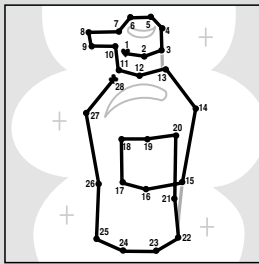

Q262 答え ドライヤー

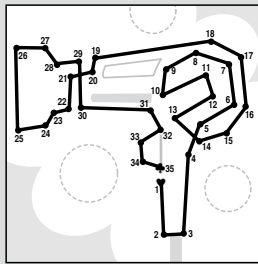

Q263 答え ハサミ

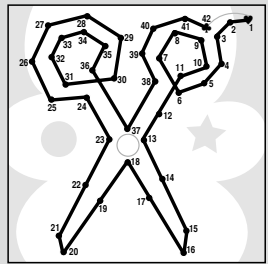

Q264 答え

B 赤ずきん

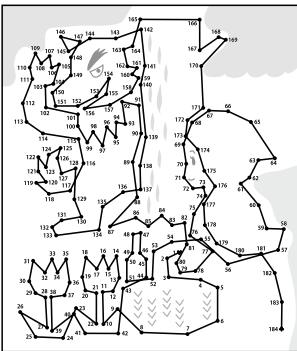

Q265 答え

B 札幌市時計台

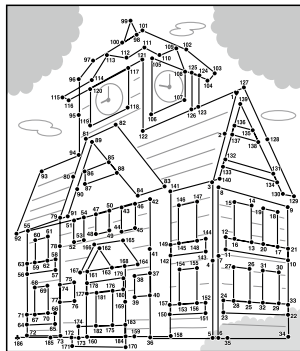

Q266 答え

C ケンタウロス

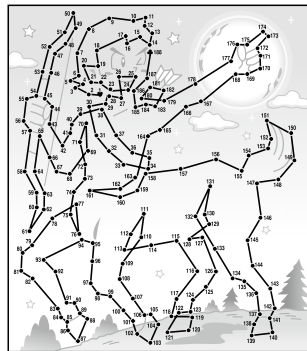

漢字てんつなぎ⑦

C 温故知新

Q267 答え 知

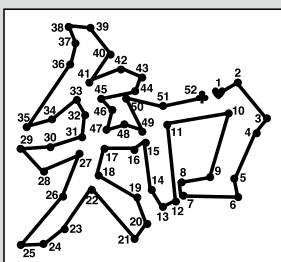

Q268 答え 故

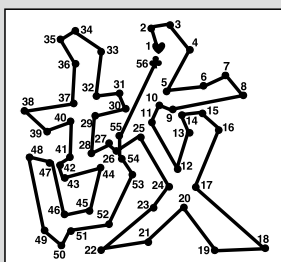

Q269 答え 温

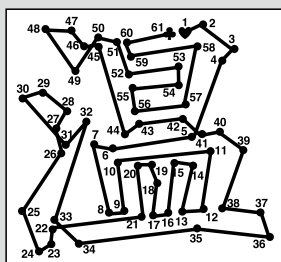

Q270 答え 新

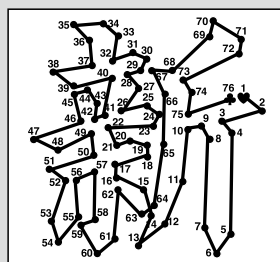

Q271 答え

B 熱帯魚

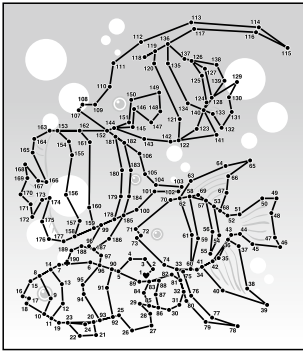

Q272 答え

C 七面鳥

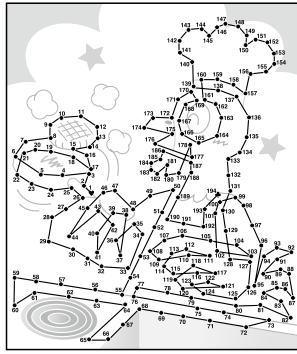

Q273 答え

A ドローン

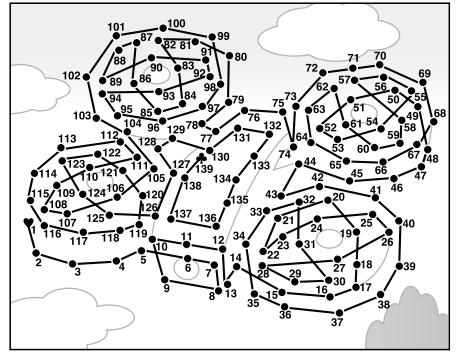

Q274 答え

C ウィンドサーフィン

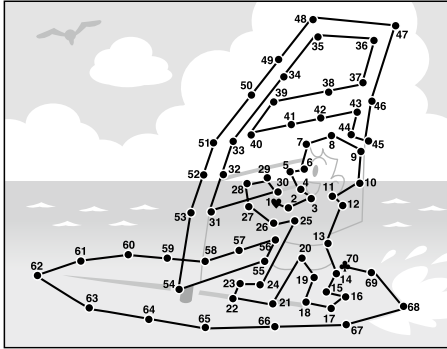

Q275 答え

B 通行止め

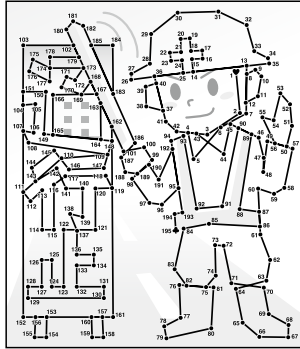

Q276 答え

D キャンピングカー

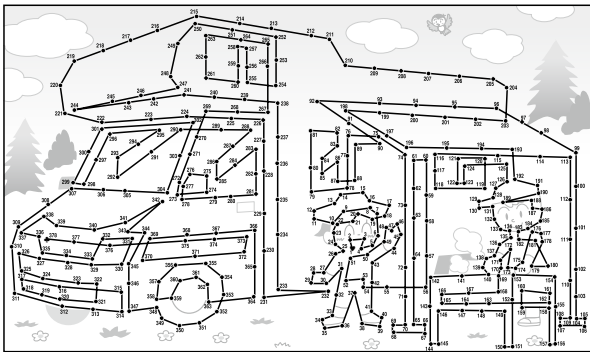

Q277 答え

A カラス

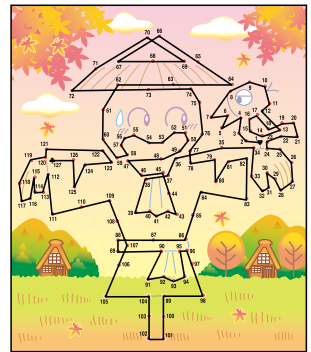

Q278 答え

A チーター

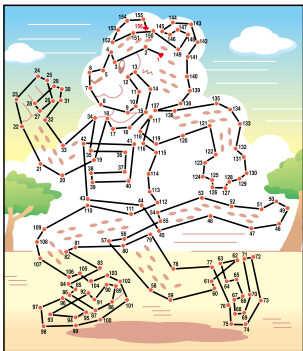

Q279 答え

A 貴族

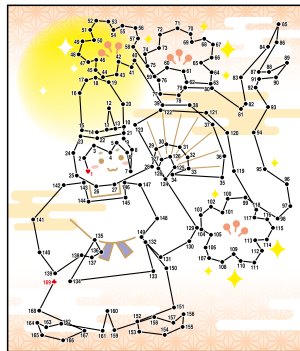

Q280 答え

C ろくろ首

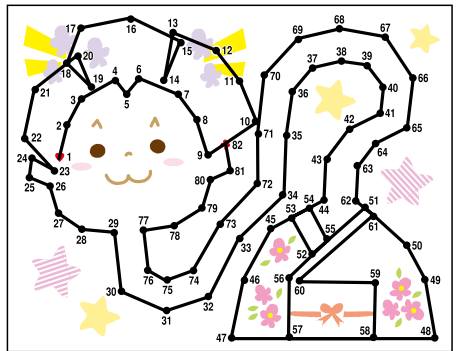

Q281 答え

A スリッパ

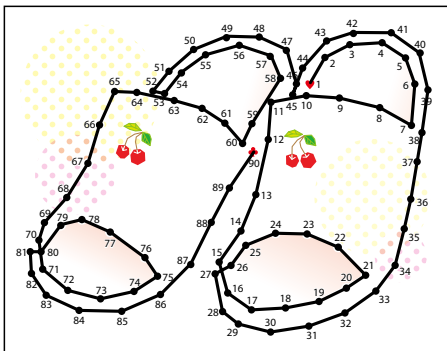

Q282 答え

A ザリガニ

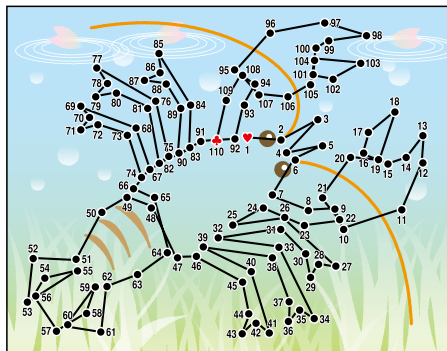

Q283 答え

C 四つ葉のクローバー

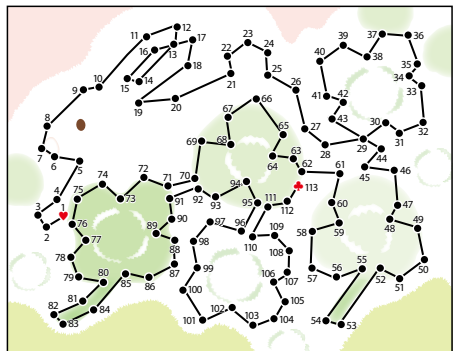

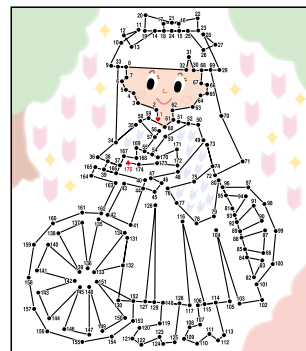
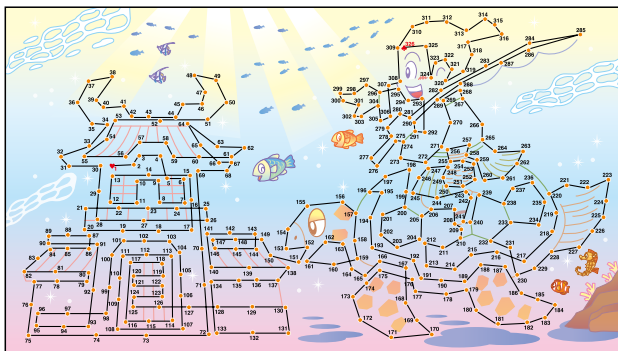

## 1/4問題の解答

- ・ 初級てんつなぎ①…34 (アイロン)
  - ・ 初級てんつなぎ②…42 (フクロウ)
  - ・ 初級てんつなぎ③…67 (プリン)
  - ・ 初級てんつなぎ④…80 (木彫りの熊)
  - ・ 初級てんつなぎ⑤…88 (鬼)
  - ・ 初級てんつなぎ⑥…96 (バウムクーヘン)
  - ・ 初級てんつなぎ⑦…112 (キング)
  - ・ 初級てんつなぎ⑧…113 (若葉マーク)
  - ・ 初級てんつなぎ⑨…119 (ドーナツ)
  - ・ 初級てんつなぎ⑩…124 (万里の長城)
  - ・ 初級てんつなぎ⑪…135 (鉛筆と消しゴム)
  - ・ 初級てんつなぎ⑫…140 (筏)
  - ・ 初級てんつなぎ⑬…151 (カーディガン)
  - ・ 初級てんつなぎ⑭…162 (紙飛行機)
  - ・ 初級てんつなぎ⑮…173 (メダル)
  - ・ 初級てんつなぎ⑯…175 (ガラケー)
  - ・ 初級てんつなぎ⑰…207 (ヨーヨー)
  - ・ 初級てんつなぎ⑱…219 (3の目)
  - ・ 初級てんつなぎ⑲…238 (韓国)
  - ・ 初級てんつなぎ⑳…262 (ドライヤー)
- ・ 漢字てんつなぎ①…C 三寒四温
  - ・ 漢字てんつなぎ②…A 一日千秋
  - ・ 漢字てんつなぎ③…C 一騎当千
  - ・ 漢字てんつなぎ④…B 不言実行
  - ・ 漢字てんつなぎ⑤…A 体力向上
  - ・ 漢字てんつなぎ⑥…B 四書五経
  - ・ 漢字てんつなぎ⑦…C 温故知新