

特選!

でんぱなぎ

デラックス Vol.8

プレゼント 問題の解答

Q1 答え

E オペラハウス

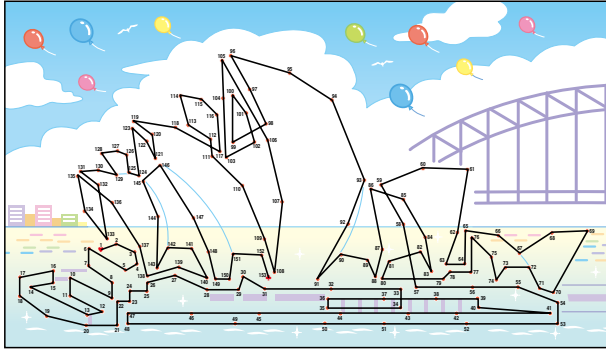

Q2 答え

C アライグマ

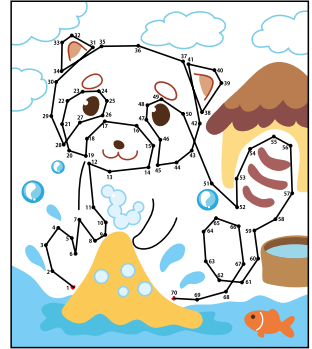

Q3 答え

A シャチ

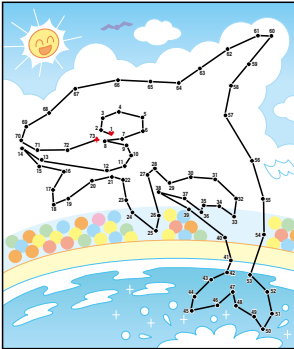

Q4 答え

B カエル

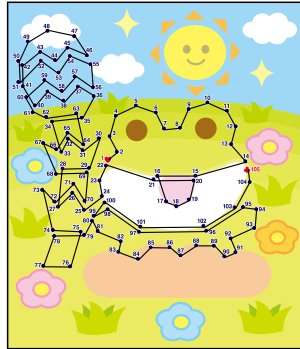

Q5 答え

B 長靴をはいた猫



Q6 答え

C シャボン玉

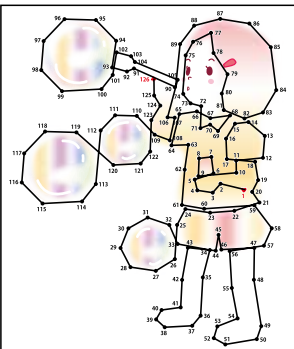

Q7 答え

A パンジー

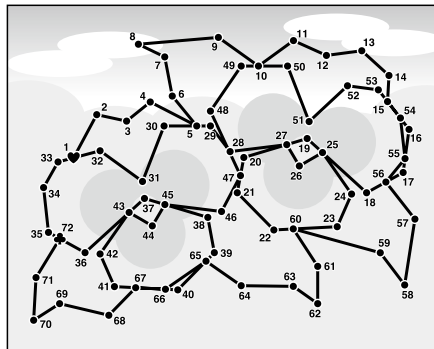

Q8 答え

C 美女と野獣

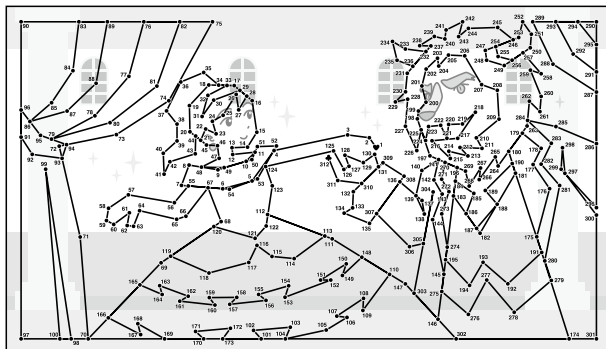

Q9 答え

A コロッセオ

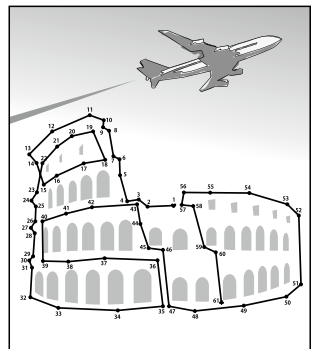

Q10 答え

C ライオン

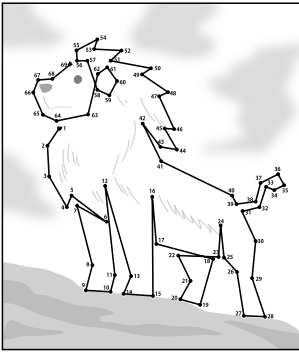

Q11 答え

C 富士山

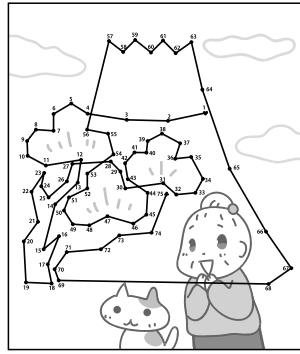

Q12 答え

C エイ

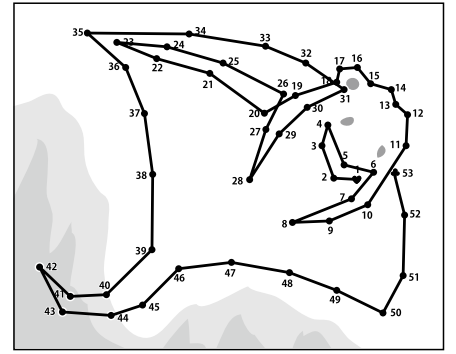

Q13 答え

B タコ

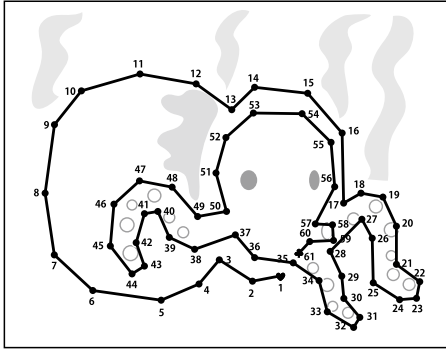

Q14 答え

B 凱旋門

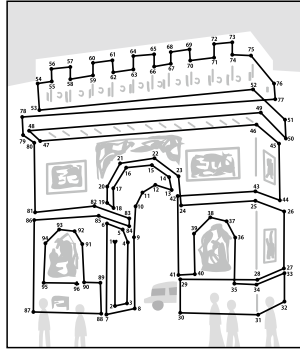

Q15 答え

A ロボット

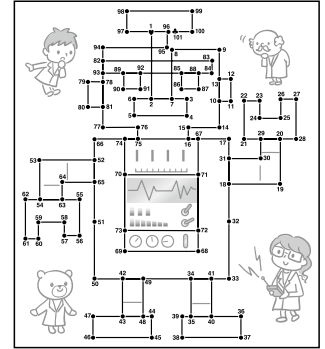

Q16 答え

A イルカはいるか?

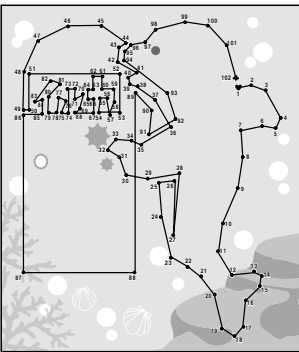

Q17 答え

C 桃太郎

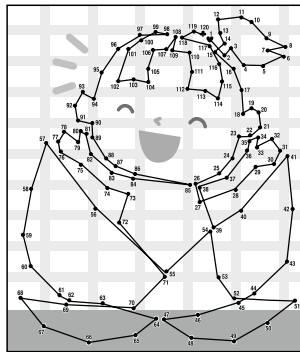

Q18 答え

C コンドル

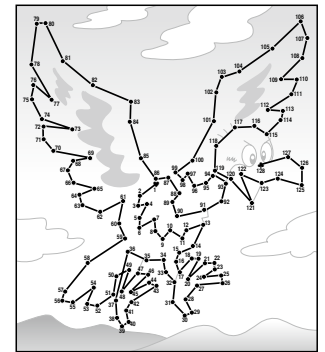

Q19 答え

A ゴンドラ

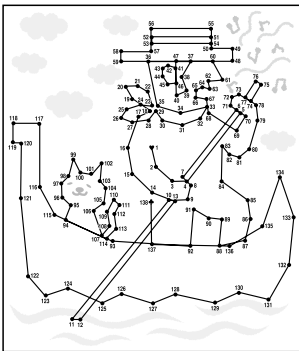

Q20 答え

A プロポーズ

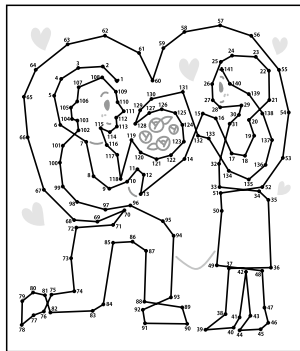

Q21 答え

A シマエナガ

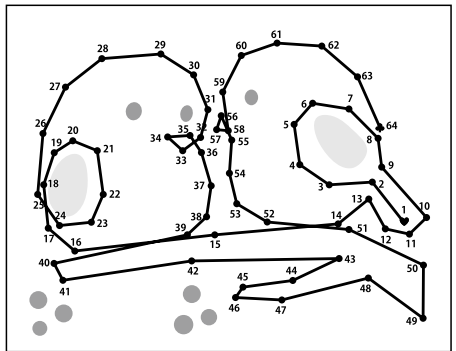

Q22 答え

A 鴨がネギを背負って来る

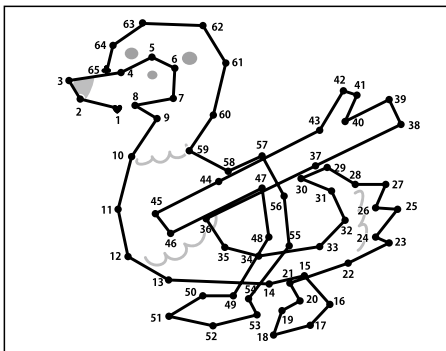

Q23 答え

B ネコ

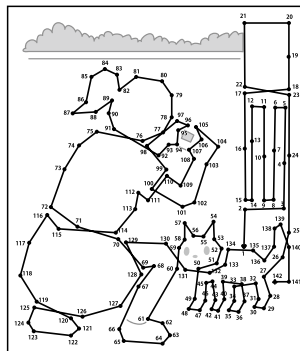

Q24 答え

C おむすびころりん

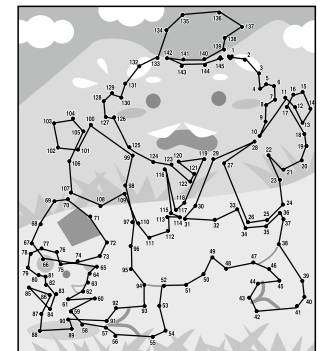

Q25 答え B スキューバダイビング

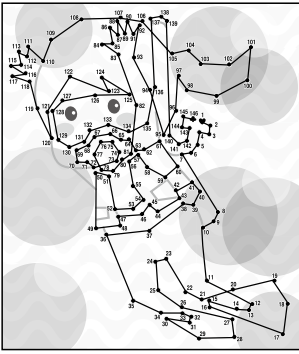

Q26 答え C モナリザ

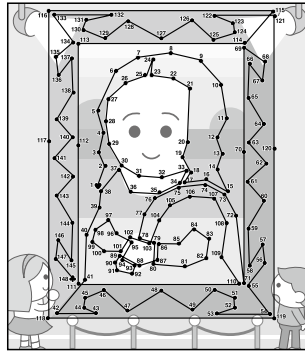

Q27 答え C リュウグウノツカイ

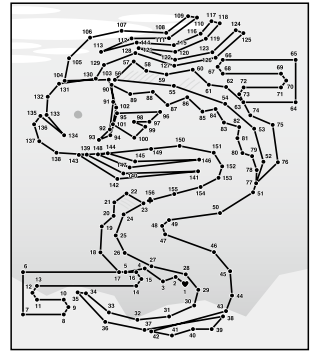

Q28 答え A ドールハウス

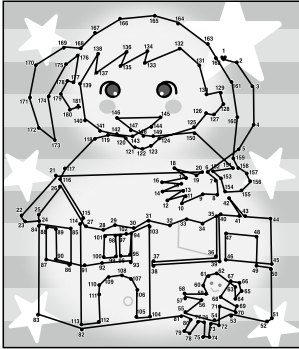

Q29 答え

C 狸

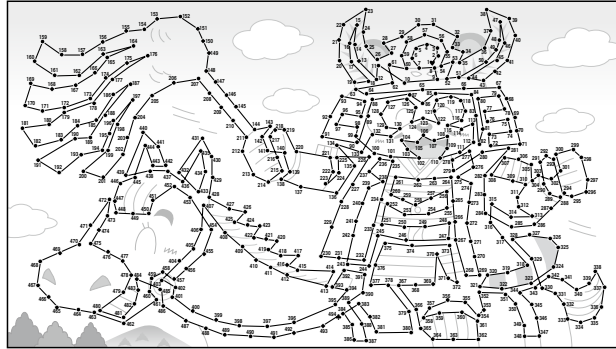

Q30 答え A イグアナ

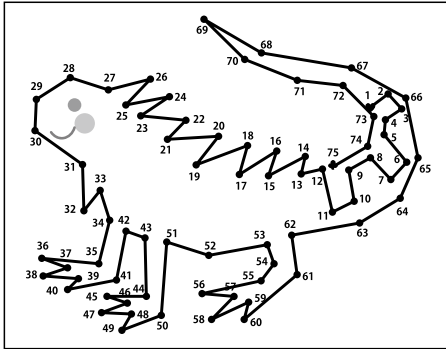

Q31 答え B ウミガメ

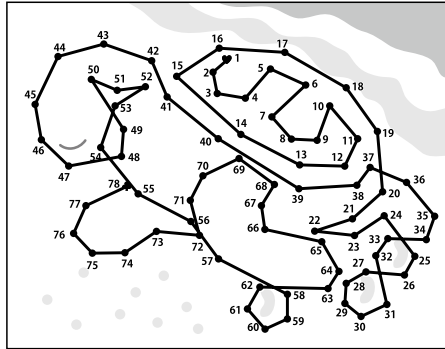

初級てんつき①

35 (トランプ「クローバー」)

Q32 答え ハート

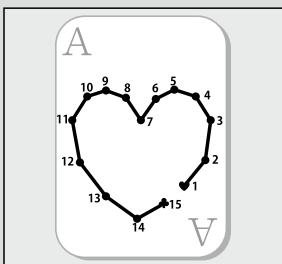

Q33 答え ダイヤ

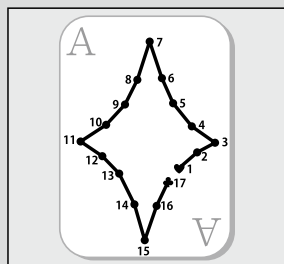

Q34 答え スペード

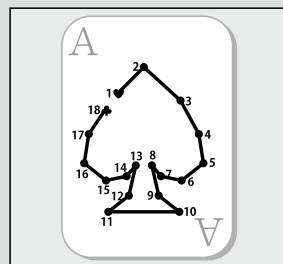

Q35 答え クローバー

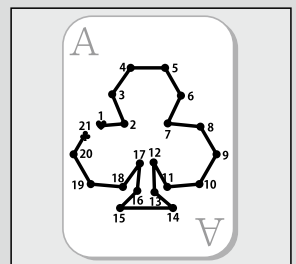

Q36 答え B アンモナイト

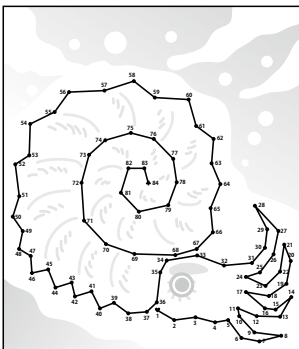

Q37 答え C ステッキ

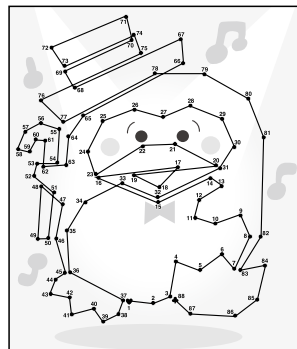

Q38 答え B ケバブ

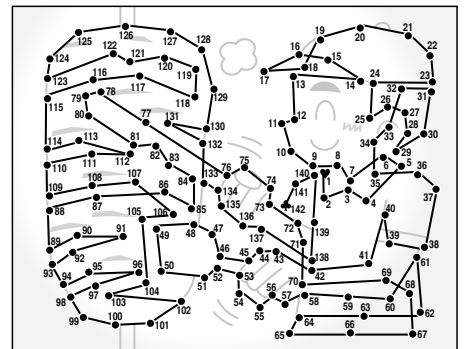

Q39 答え

A 餃子

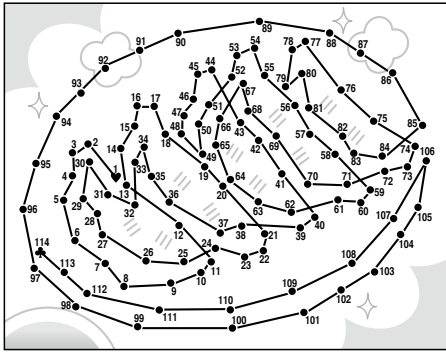

Q40 答え

C コルコバードのキリスト像



初級てんつなぎ②

44 (コンパス)

Q41 答え

消しゴム

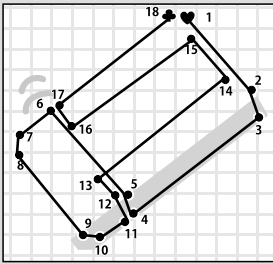

Q42 答え

ハサミ

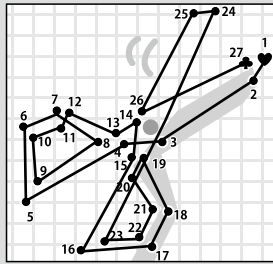

Q43 答え

セロハンテープ

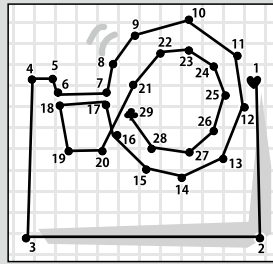

Q44 答え

コンパス

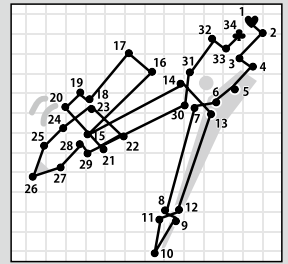

Q45 答え

B フラダンス

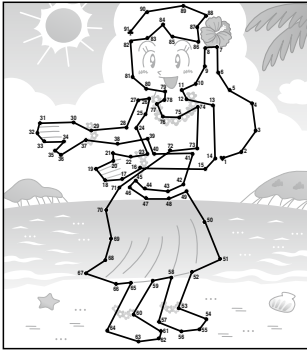

Q46 答え

B 大工



Q47 答え

C ざるそば

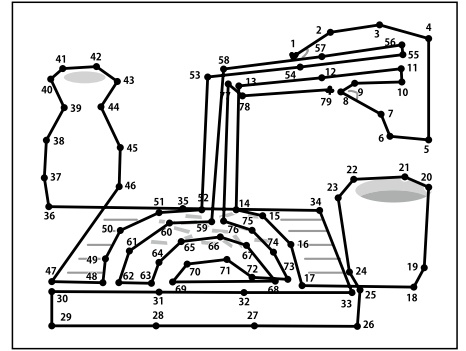

Q48 答え

C わんこそば

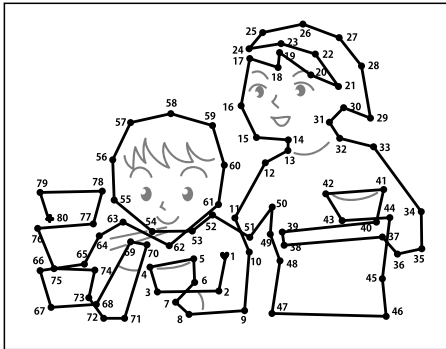

Q49 答え

A 大掃除



Q50 答え

A 三角のポーズ

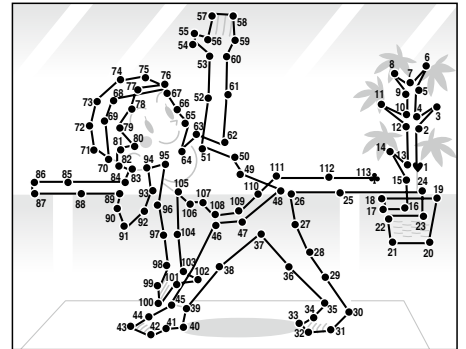

Q51 答え

B 瞑想

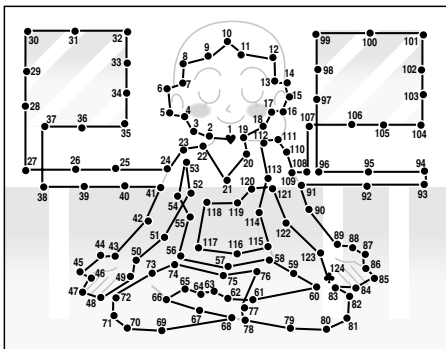

Q52 答え

C 4コ

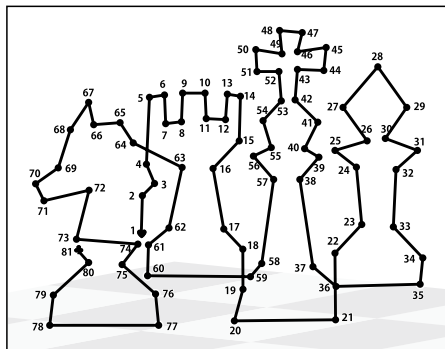

Q53 答え

B 跳び箱

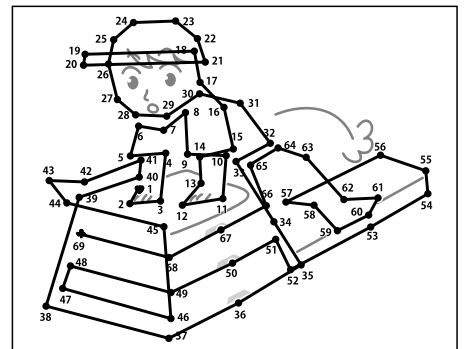

Q54 答え A アメリカ大統領

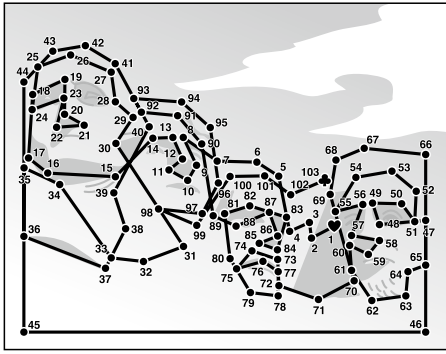

Q55 答え A 平和祈念像

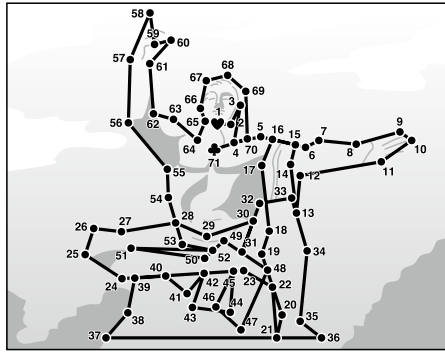

Q56 答え A ナスカの地上絵

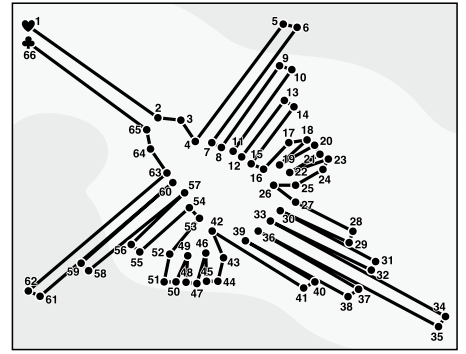

Q57 答え B アンコール・ワット

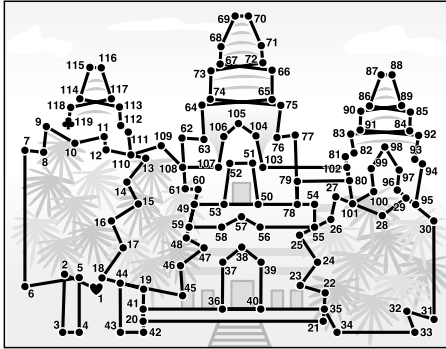

Q58 答え A 因幡の白兎

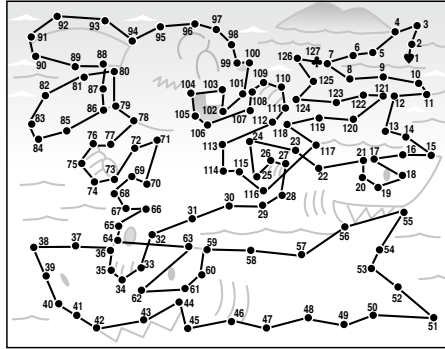

Q59 答え C ハンプティ・ダンプティ

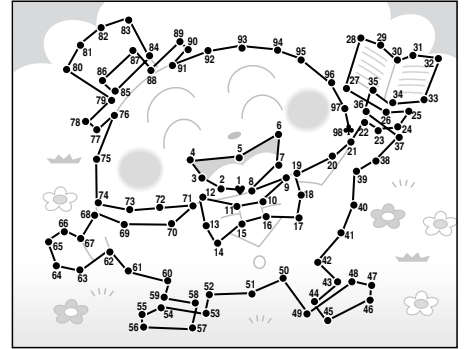

Q60 答え C 荷造り

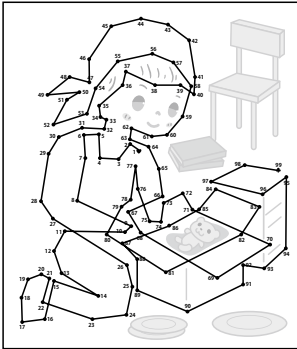

初級てんつき③

62 (オンブバッタ)

Q61 答え てんとう虫

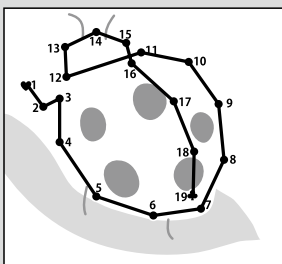

Q62 答え オンブバッタ

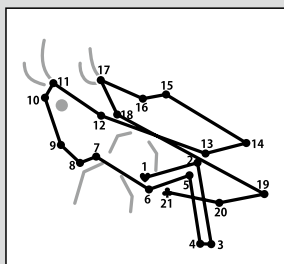

Q63 答え 蝶

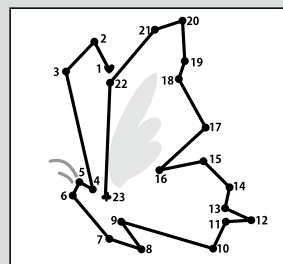

Q64 答え ミツバチ

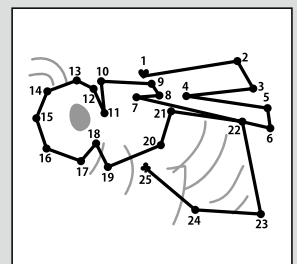

初級てんつき④

67 (サムズアップ)

Q65 答え グー

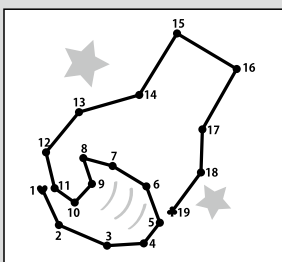

Q66 答え パー

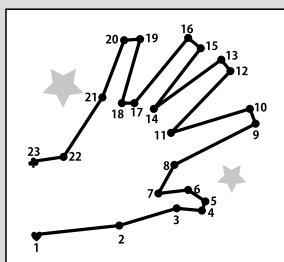

Q67 答え サムズアップ

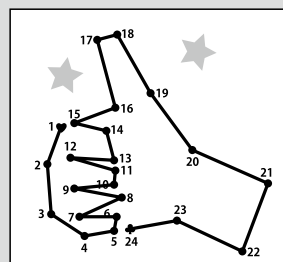

Q68 答え チョキ

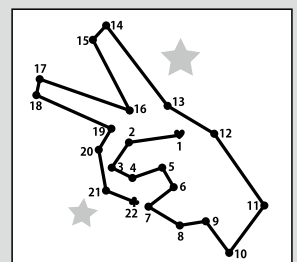

Q69 答え

A パン

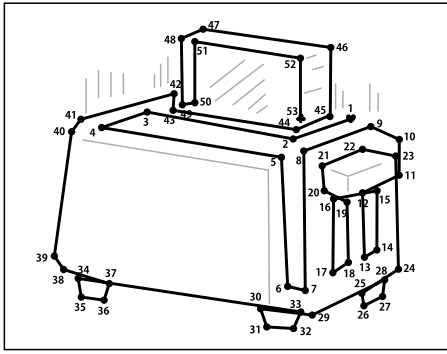

Q70 答え

C 潜水艦

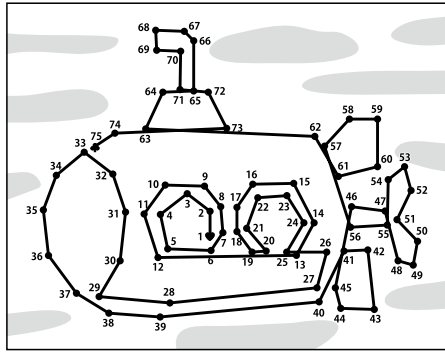

Q71 答え

C モモンガ

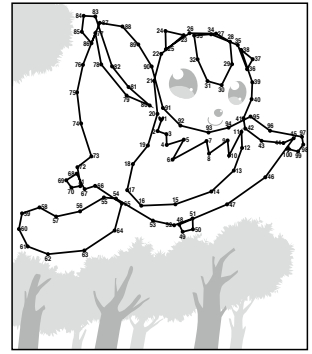

Q72 答え

A ジェットコースター

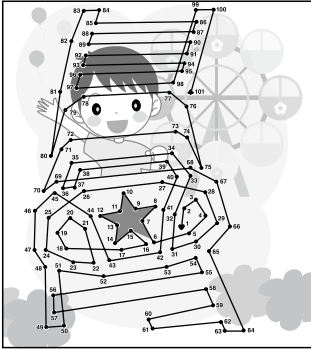

初級てんつき⑤

75 (聴診器)

Q73 答え

松葉杖

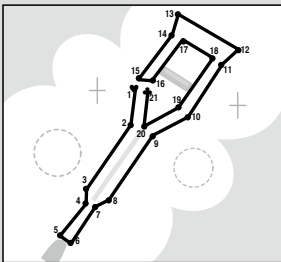

Q74 答え

ハサミ

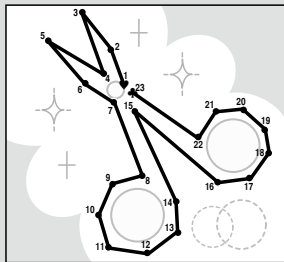

Q75 答え

聴診器

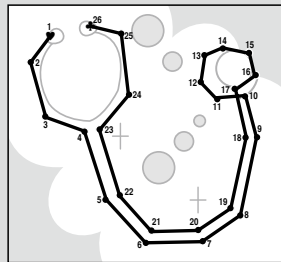

Q76 答え

注射器

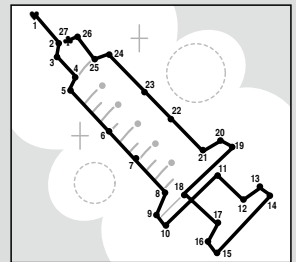

初級てんつき⑥

77 (洗濯板)

Q77 答え

洗濯板

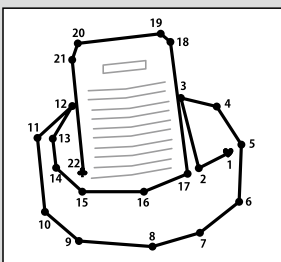

Q78 答え

塵取りと箒

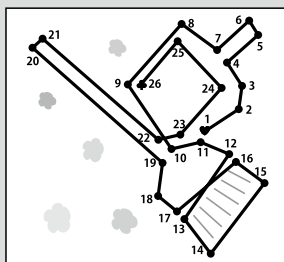

Q79 答え

かまど

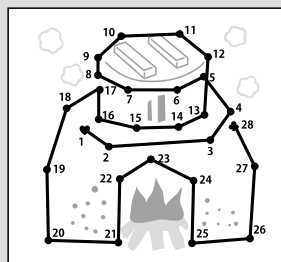

Q80 答え

蓄音機

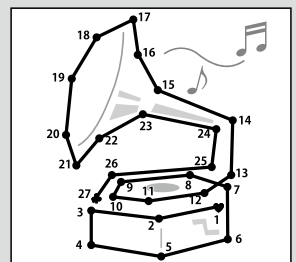

Q81 答え

C ショートケーキ

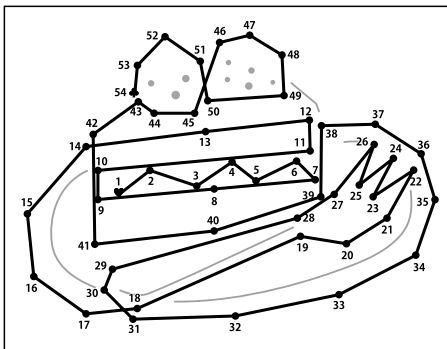

Q82 答え

A 編み物

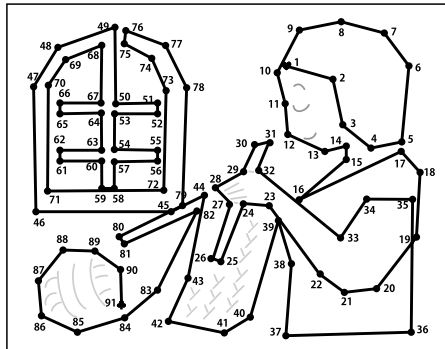

Q83 答え

A 空飛ぶ自動車

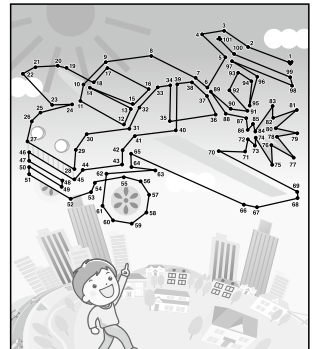

Q84 答え

A ペンギン D シロクマ

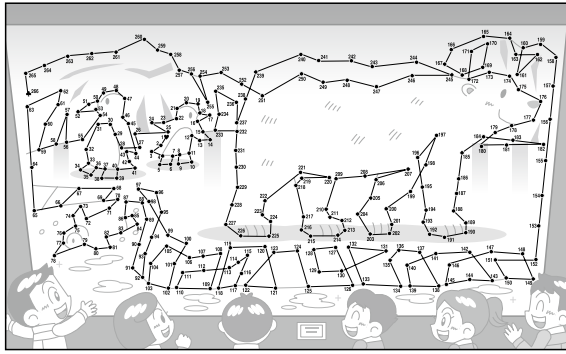

初級てんつなぎ⑦

86 (標識「転回禁止」)

Q85 答え 駐車可

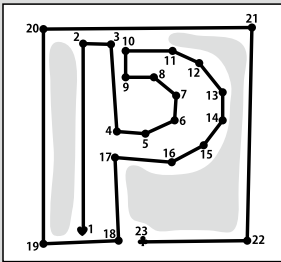

Q86 答え 転回禁止

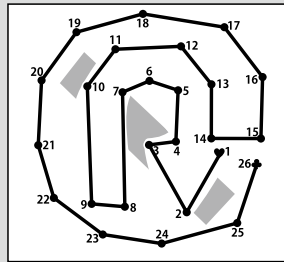

Q87 答え 車両進入禁止

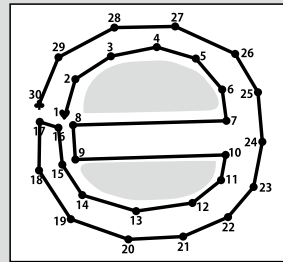

Q88 答え 信号機あり

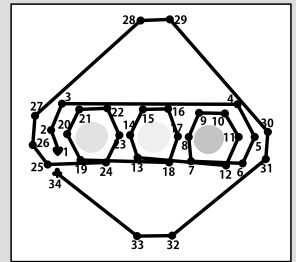

Q89 答え B 準備運動

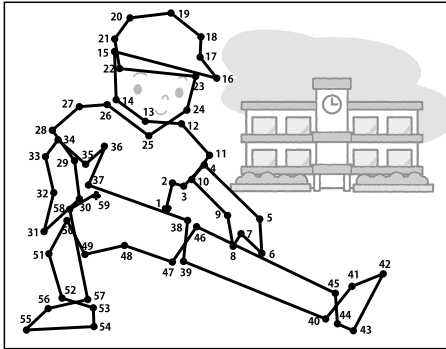

Q90 答え A 逆上がり

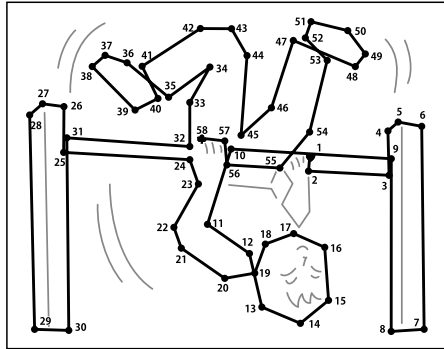

Q91 答え C エスカレーター

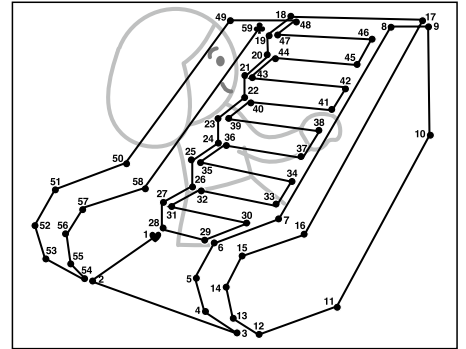

Q92 答え B カンファー

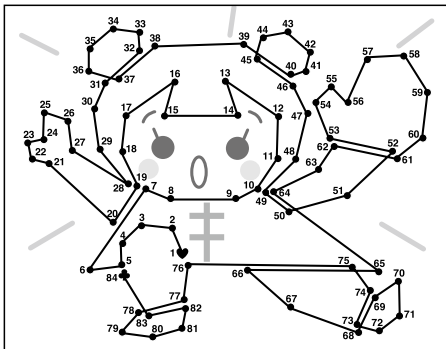

初級てんつなぎ⑧

93 (釣り「魚」)

Q93 答え 魚

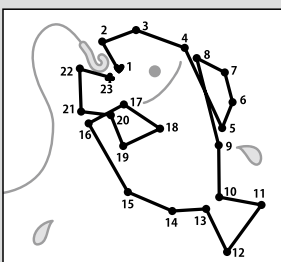

Q94 答え タコ

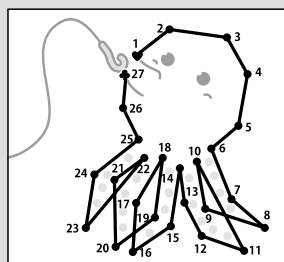

Q95 答え 空き缶

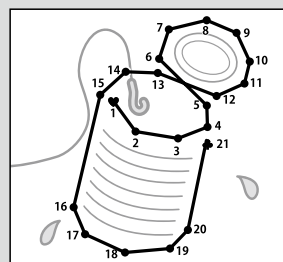

Q96 答え 長靴

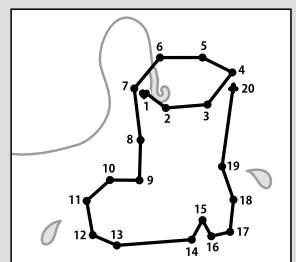

Q97 答え

B オープンバス

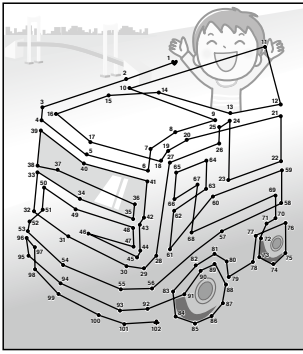

Q98 答え

B サル

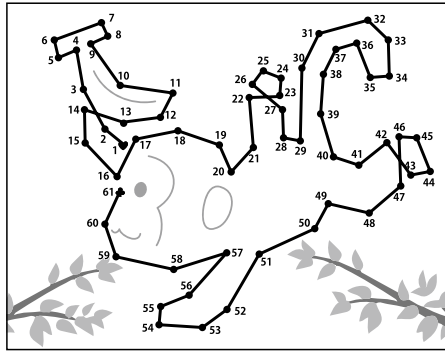

Q99 答え

A 鶴

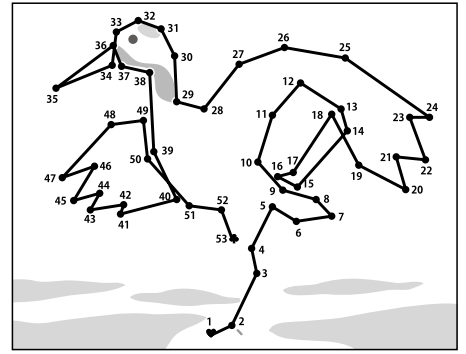

Q100 答え

A バッター

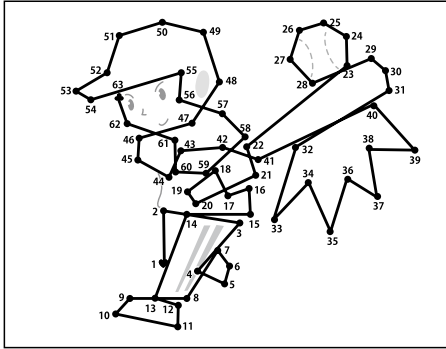

Q101 答え

B カニ

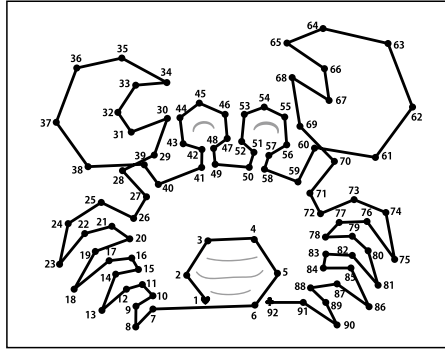

Q102 答え

C 乳搾り

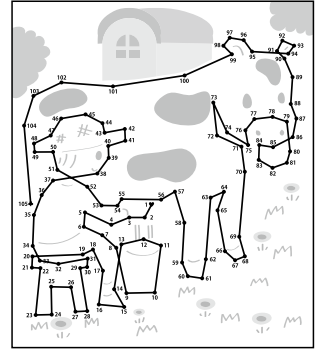

Q103 答え

A パンダ

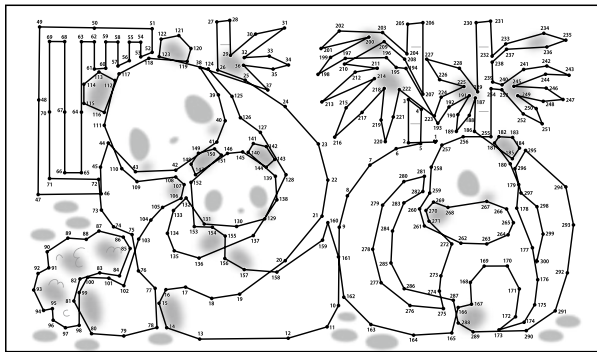

Q104 答え

A 魔法使い

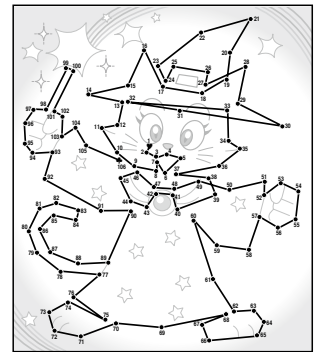

Q105 答え

A 交通整理

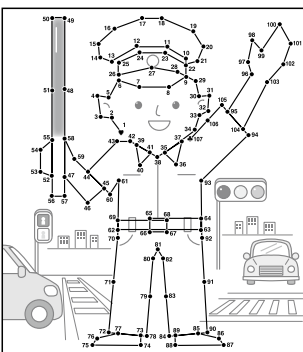

Q106 答え

B バドミントン

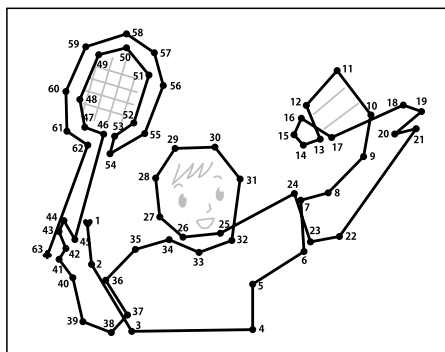

Q107 答え

C バasketボール

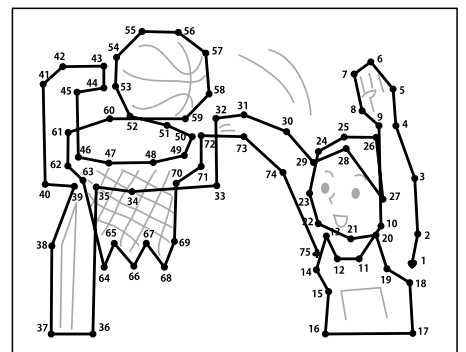

Q108 答え

C ラーメン

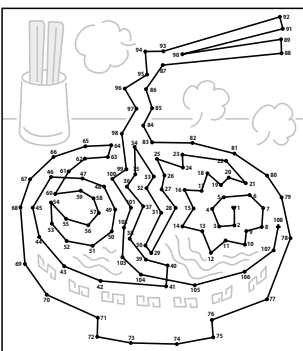

初級てんつなぎ⑨

110 (パトカー)

Q109 答え はしご車

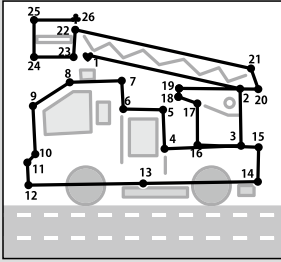

Q110 答え パトカー

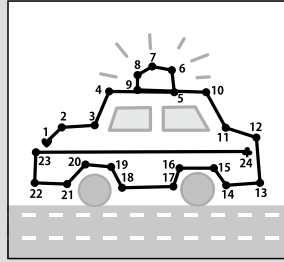

Q111 答え ショベルカー

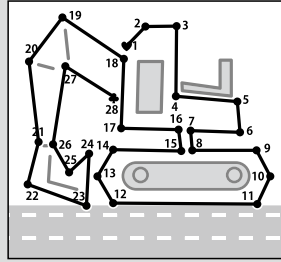

Q112 答え ダンプカー

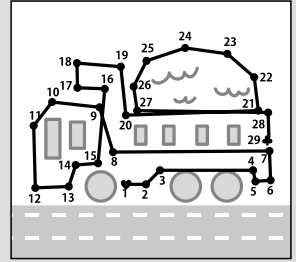

初級てんつなぎ⑩

113 (ピコピコハンマー)

Q113 答え ピコピコハンマー

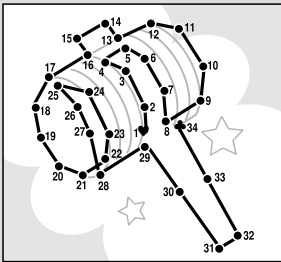

Q114 答え 積み木

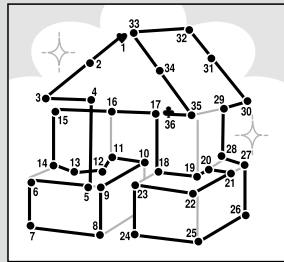

Q115 答え けん玉

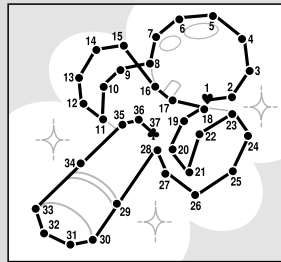

Q116 答え テディベア

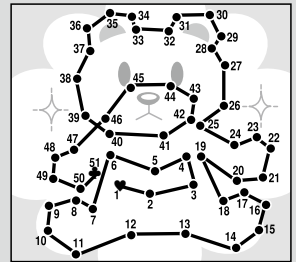

Q117 答え B ナマケモノ

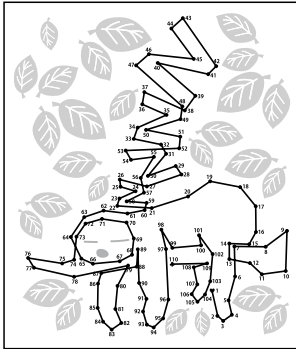

Q118 答え A 雨傘

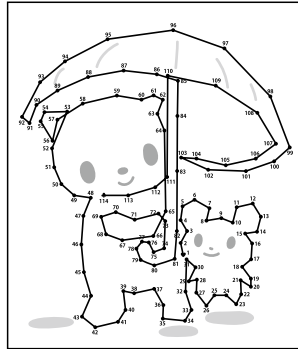

初級てんつなぎ⑪

119 (シャベル)

Q119 答え シャベル

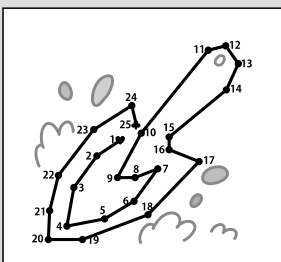

Q120 答え バドミントンの羽根

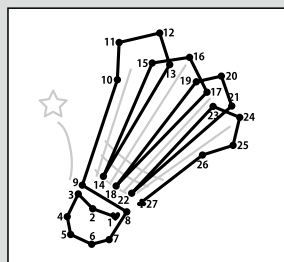

Q121 答え バットとボール

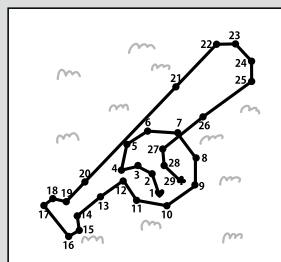

Q122 答え サッカーボール

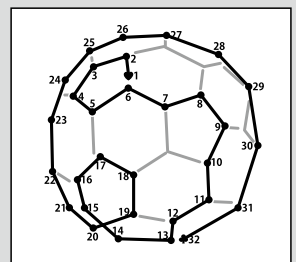

初級てんつなぎ⑫

125 (ヤドカリ)

Q123 答え ハコフグ

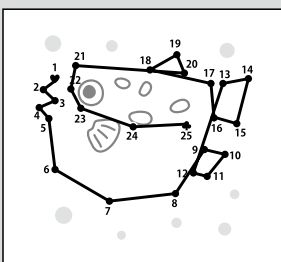

Q124 答え 熱帯魚

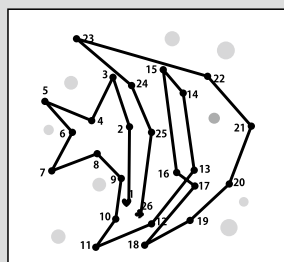

Q125 答え ヤドカリ

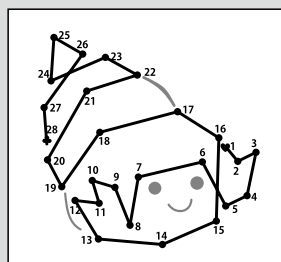

Q126 答え マンボウ

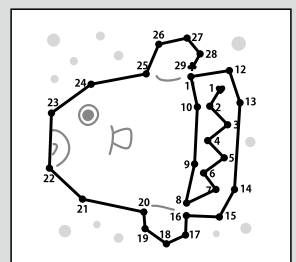

Q127 答え

B 焼きそば

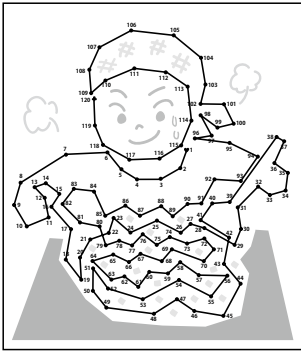

Q128 答え

A ポールダンス

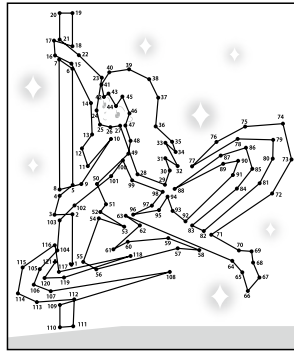

Q129 答え

A じょうろ

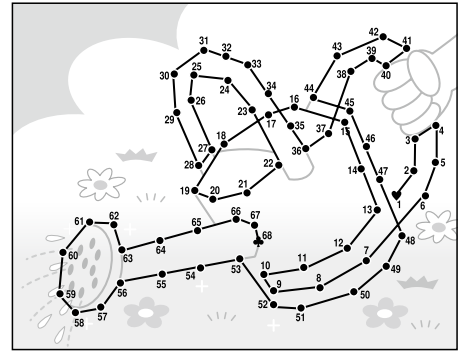

Q130 答え

C 剪定ばさみ

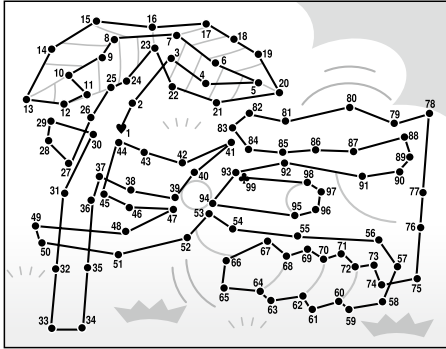

Q131 答え

C シャワー

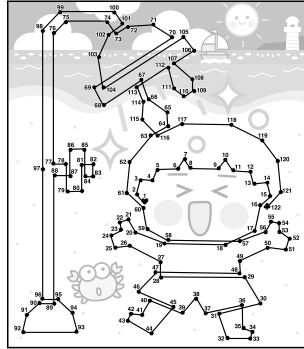

Q132 答え

A 水をあげる

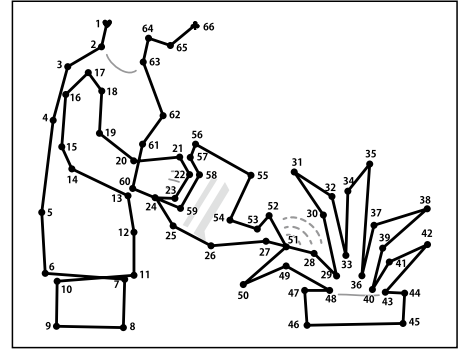

Q133 答え

C すぎのこ

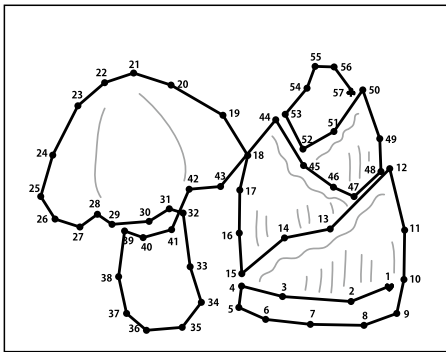

Q134 答え

B ピノキオ

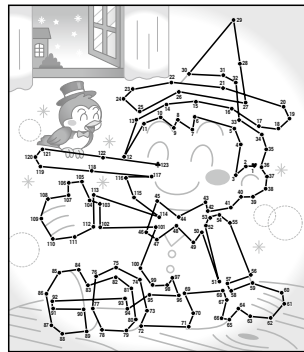

初級てんつなぎ⑬

135 (ベレー帽)

Q135 答え ベレー帽

Q136 答え ニット帽

Q137 答え リボン

Q138 答え カチューシャ

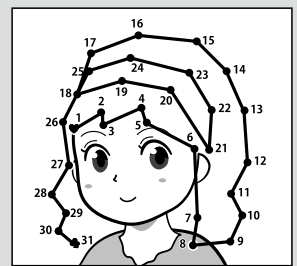
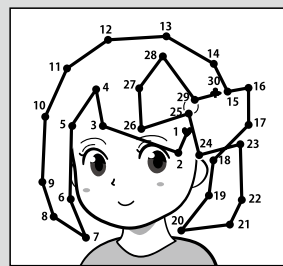
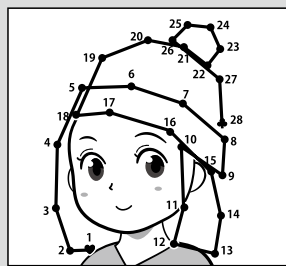
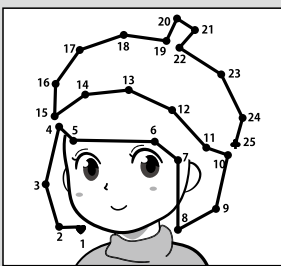

初級てんつなぎ⑭

142 (ホタテ)

Q139 答え エビ

Q140 答え カツオ

Q141 答え イカ

Q142 答え ホタテ

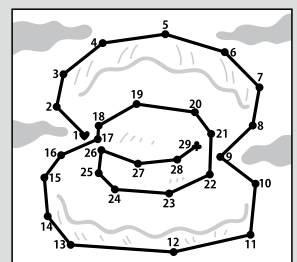
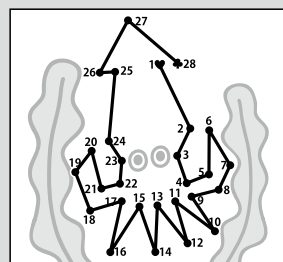
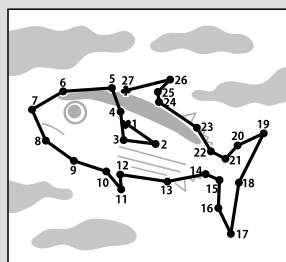
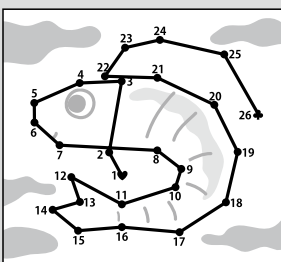

Q143 答え

A 宇宙人

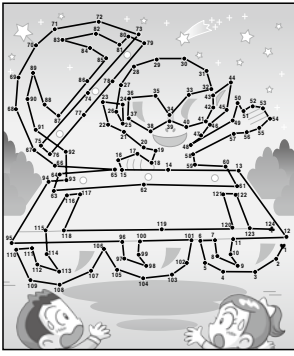

Q144 答え

D 毘沙門天

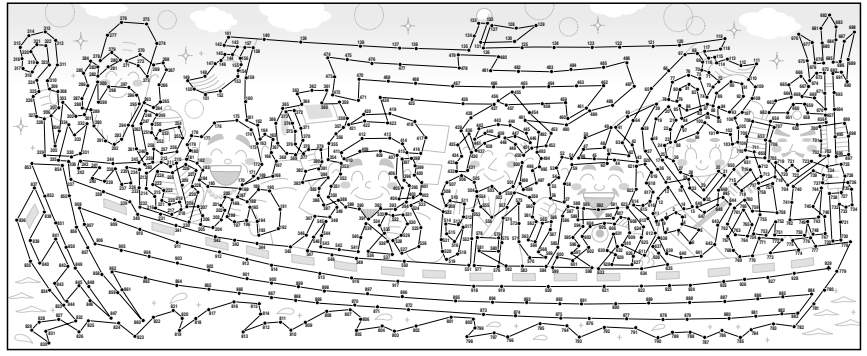

Q145 答え

E オペラ座の怪人

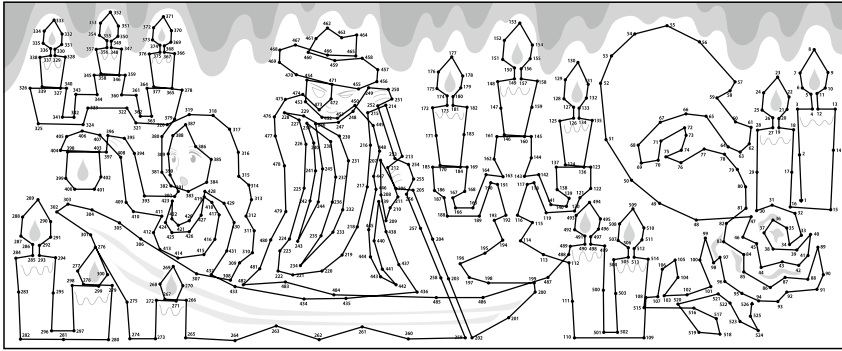

Q146 答え

C セタ祭り

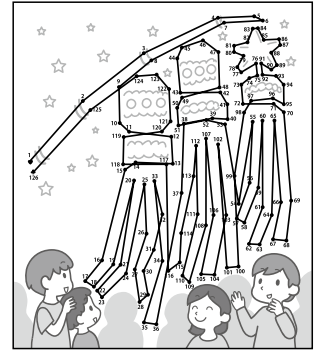

Q147 答え

A スフィンクス

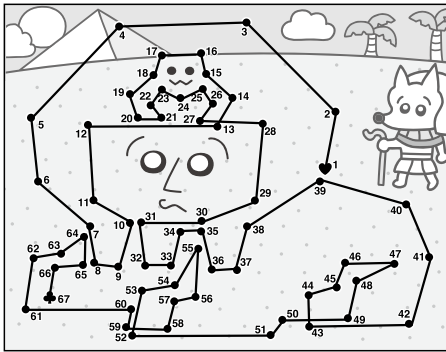

Q148 答え

A 恐竜

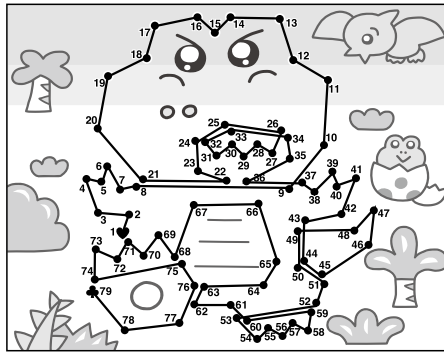

初級てんつなぎ⑮

152 (ラグビー)

Q149 答え

クライミング

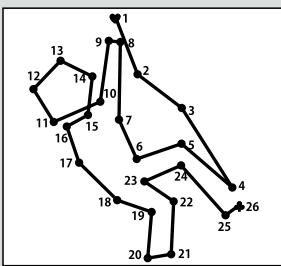

Q150 答え

射撃

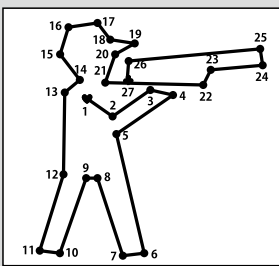

Q151 答え

フェンシング

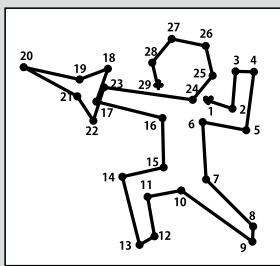

Q152 答え

ラグビー

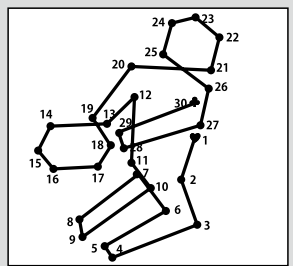

Q153 答え

B ぞうさん

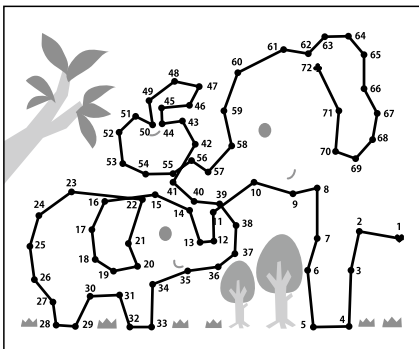

Q154 答え

A ぶんぶんぶん

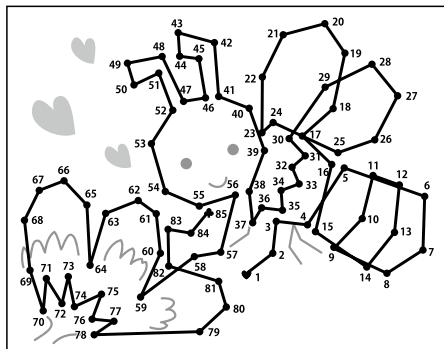

Q155 答え

C ボクシング

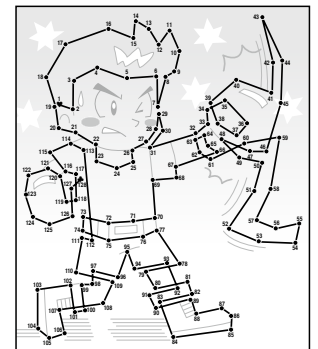

Q156 答え A だるま

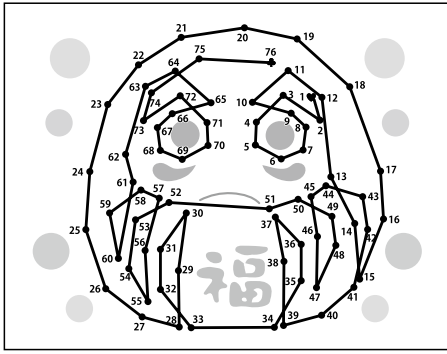

Q157 答え C 招き猫

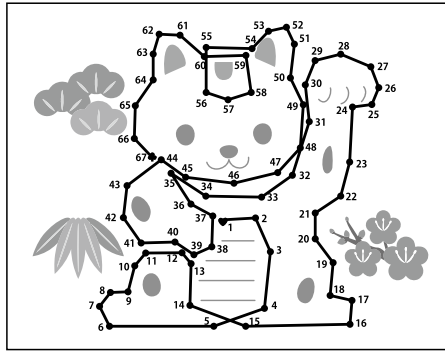

Q158 答え B やかん

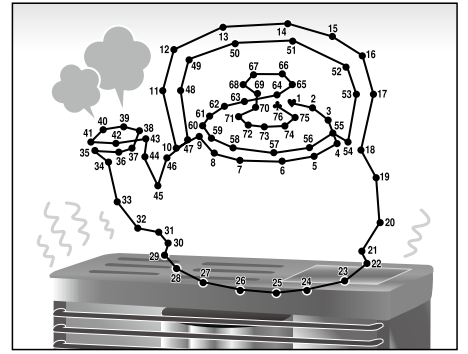

Q159 答え A 鉛筆削り

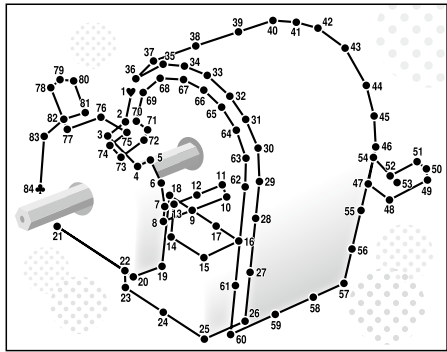

Q160 答え B ブランコ

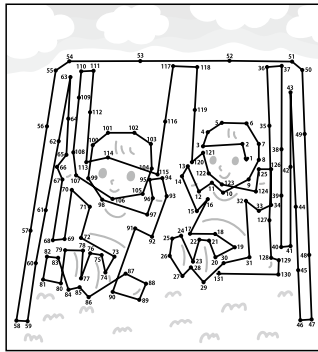

Q161 答え A ペガサス

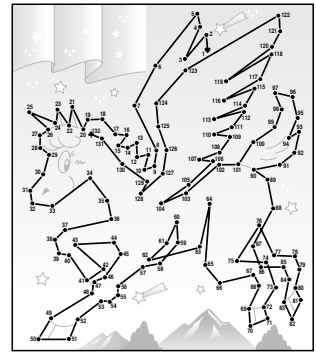

初級てんつなぎ⑬

164 (金魚鉢)

Q162 答え 犬小屋

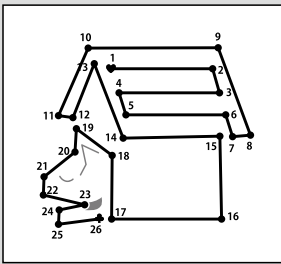

Q163 答え 鳥かご

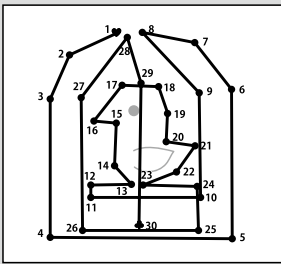

Q164 答え 金魚鉢

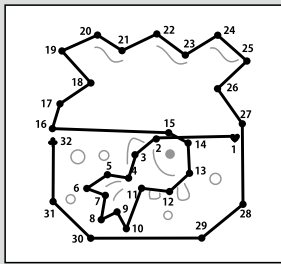

Q165 答え キャットタワー

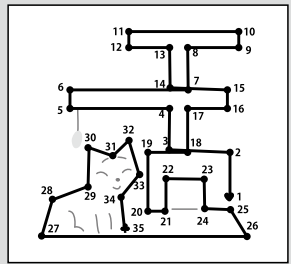

Q166 答え A 公衆電話

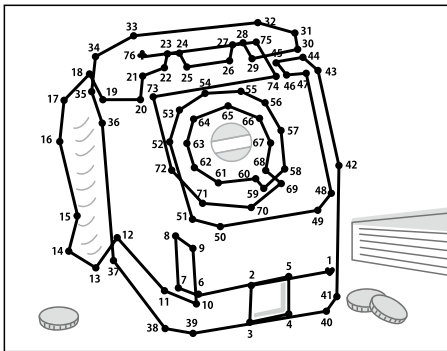

Q167 答え A ちゃぶ台

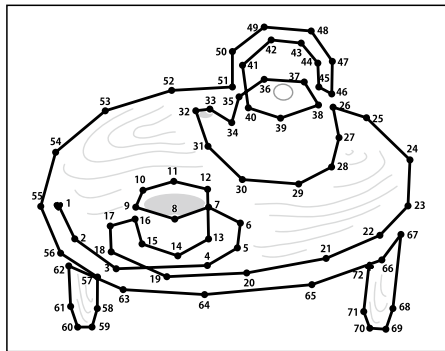

Q168 答え C 美容師

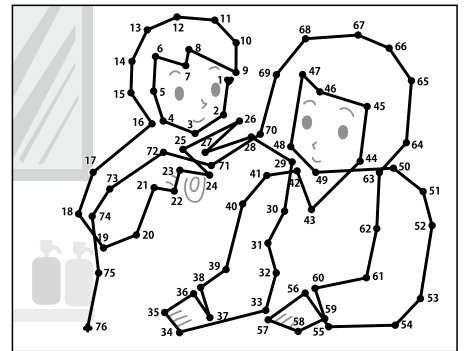

Q169 答え A 三つ編み

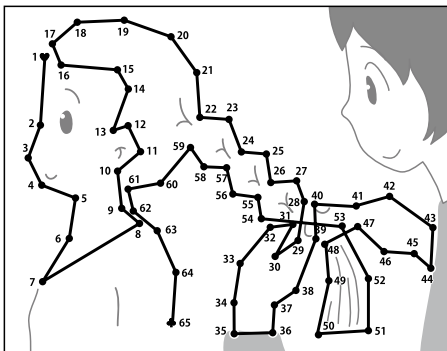

初級てんつなぎ①

170 (机)

Q170 答え 机

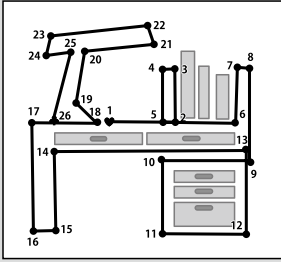

Q171 答え 椅子

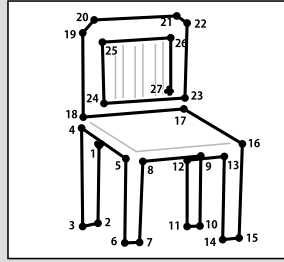

Q172 答え ベッド

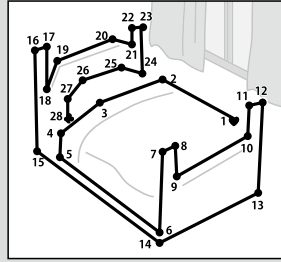

Q173 答え ソファ

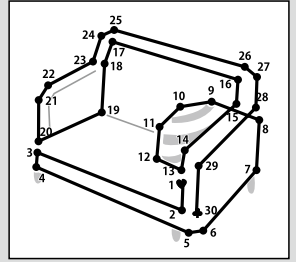

Q174 答え C コンパス

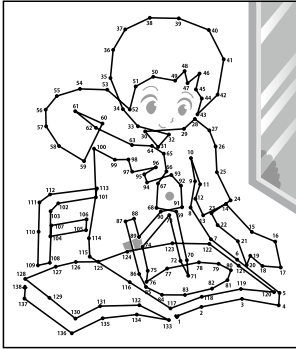

初級てんつなぎ②

175 (麻雀牌「中」)

Q175 答え 中

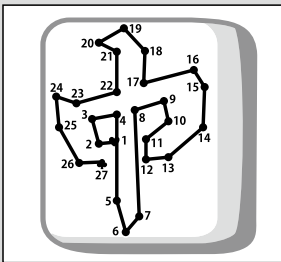

Q176 答え 東

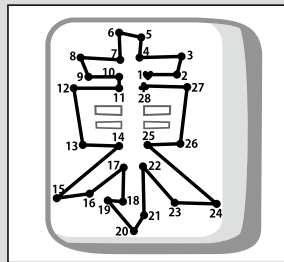

Q177 答え 西

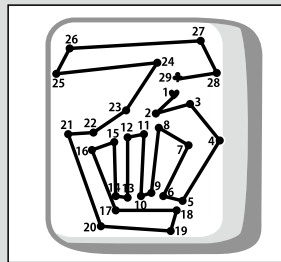

Q178 答え 北

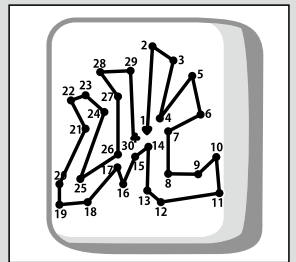

Q179 答え C 河童

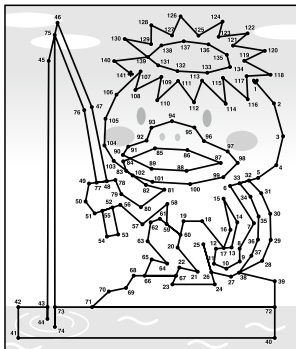

Q180 答え B サッカー

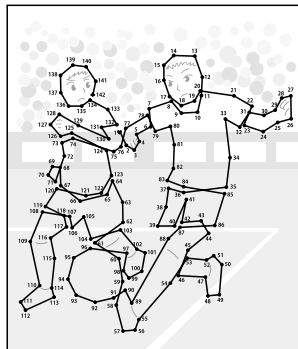

Q181 答え B わたあめ

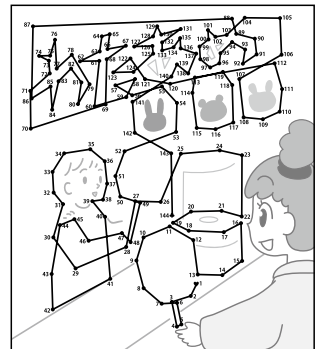

Q182 答え A ケンケンパ

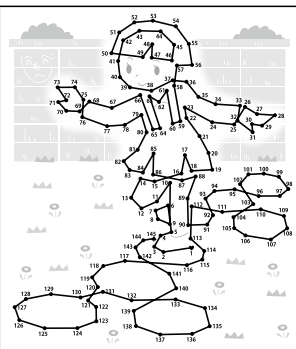

Q183 答え C つなわり

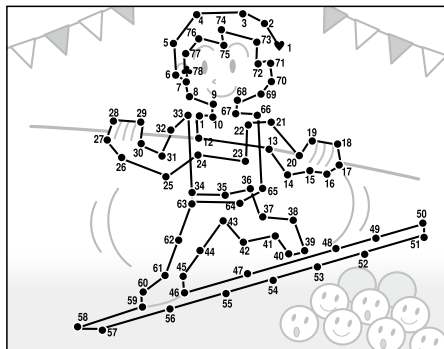

Q184 答え B 穴を掘る

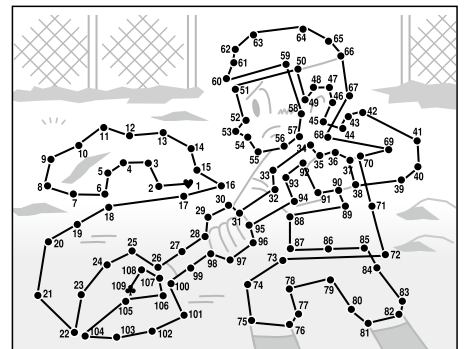

Q185 答え ヘリコプター

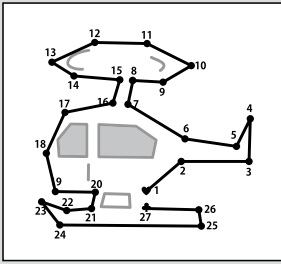

Q186 答え プロペラ機

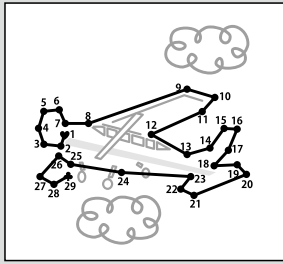

Q187 答え ジェット機

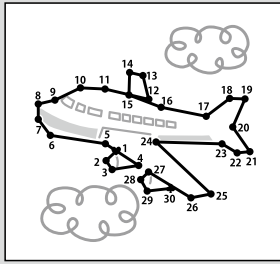

Q188 答え UFO

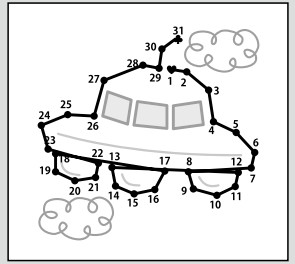

Q189 答え

E 6匹

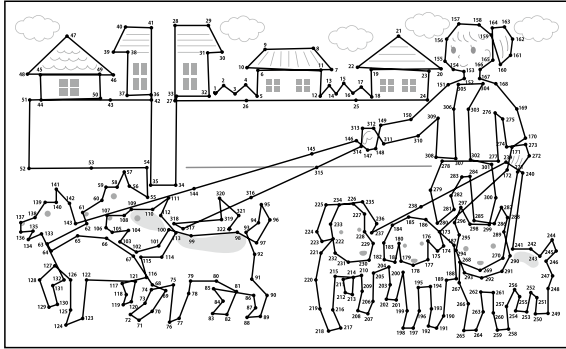

Q190 答え

B 剣道

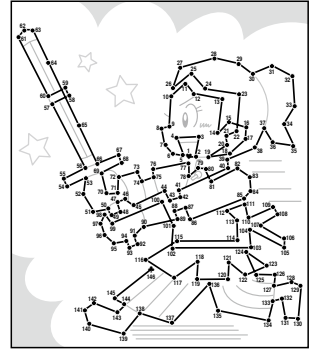

Q191 答え

B ゴム跳び

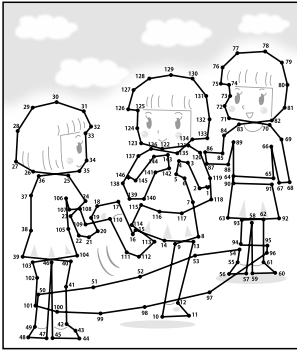

Q192 答え

B ハイハイ

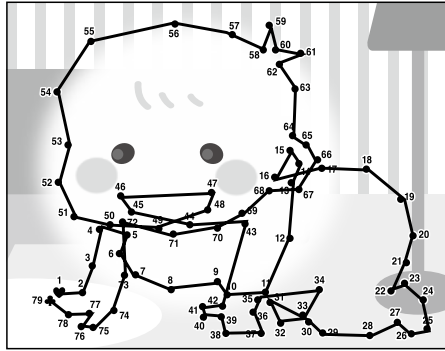

Q193 答え

A 人魚姫

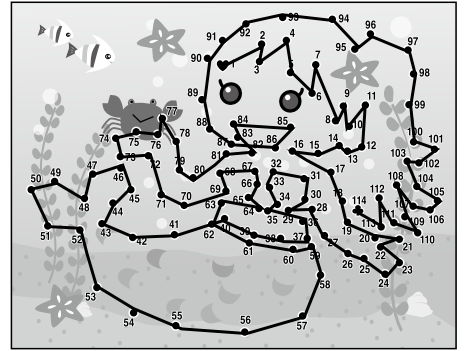

Q194 答え

B ダーツ

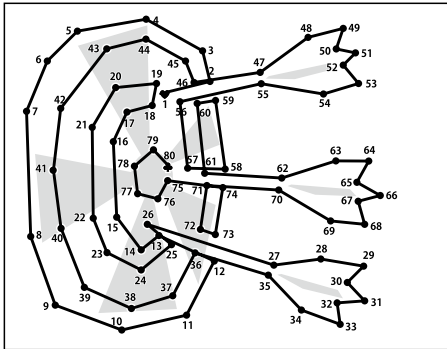

Q195 答え

C ビリヤード

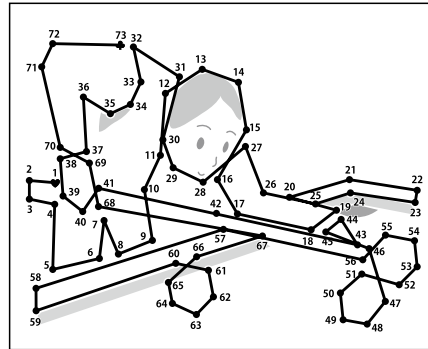

Q196 答え

B クリームソーダ

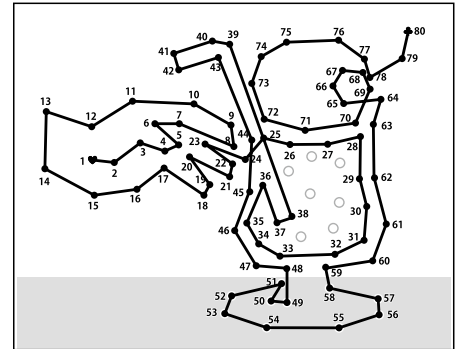

Q197 答え

C カセットテープ

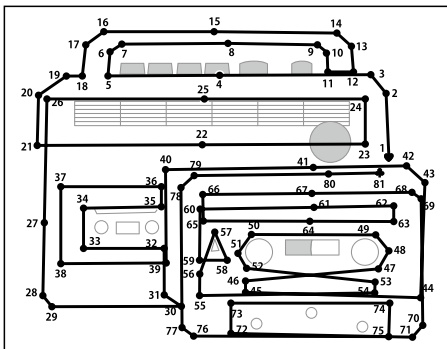

Q198 答え

C 線路は続くよどこまでも

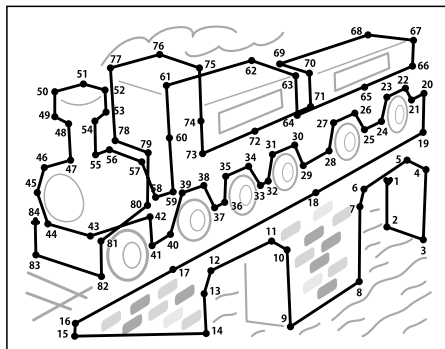

Q199 答え

A かわいい魚屋さん

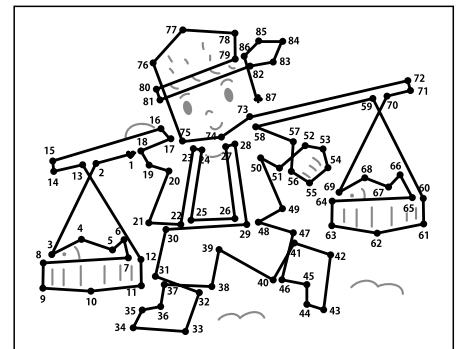

Q200 答え

C お手玉

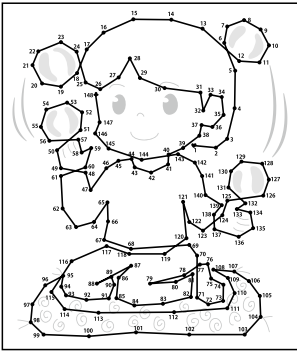

初級てんつなぎ⑩

202 (どら焼き)

Q201 答え キャンディ

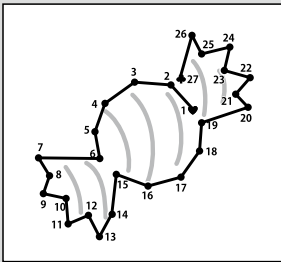

Q202 答え どら焼き

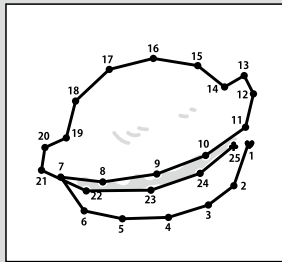

Q203 答え プリン

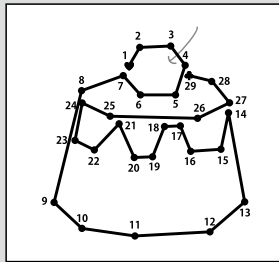

Q204 答え パフェ

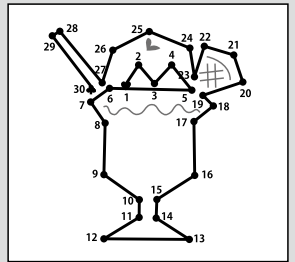

Q205 答え

A 缶けり

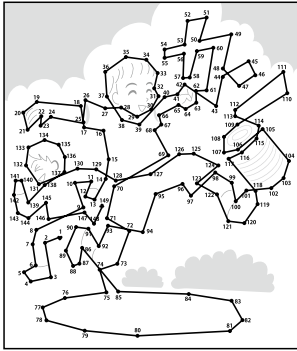

Q206 答え

A フラフープ

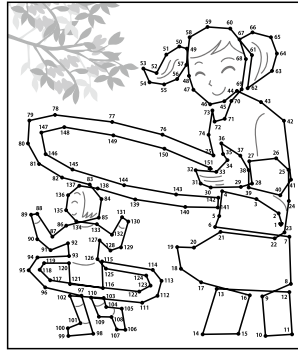

初級てんつなぎ⑪

209 (厳島神社)

Q207 答え クラーク博士像

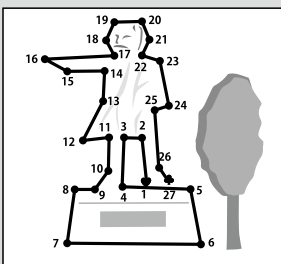

Q208 答え 通天閣

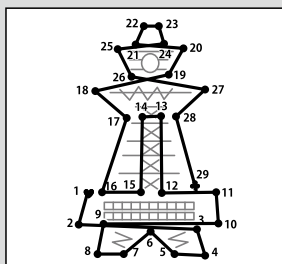

Q209 答え 厳島神社

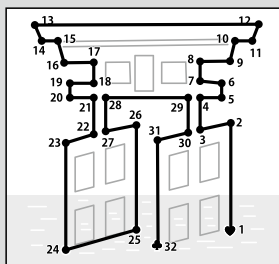

Q210 答え 雷門

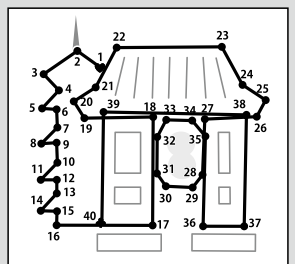

Q211 答え

C テレビゲーム

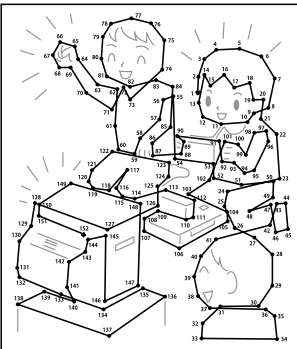

Q212 答え

C 丸型ポスト

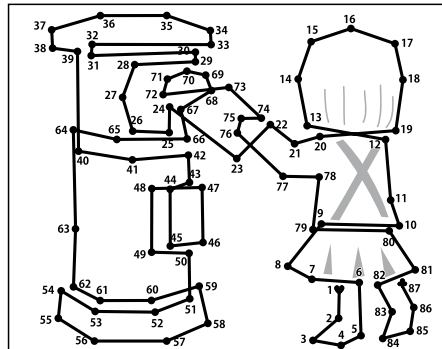

Q213 答え

B 紙芝居

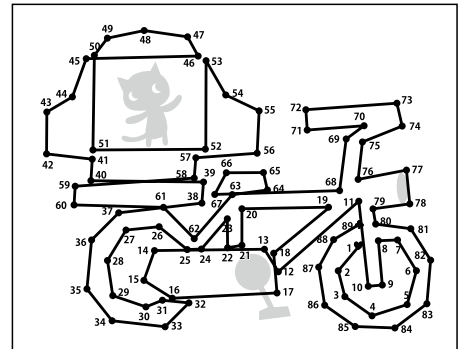

Q214 答え

B 竹馬

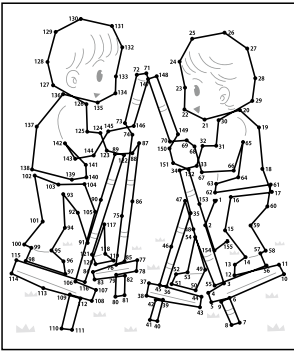

Q215 答え

B ディスコ

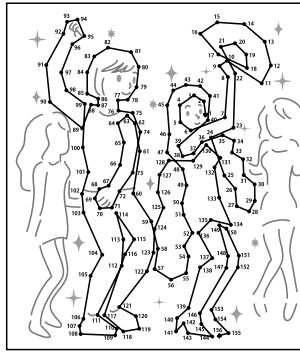

Q216 答え

C ロープウェイ

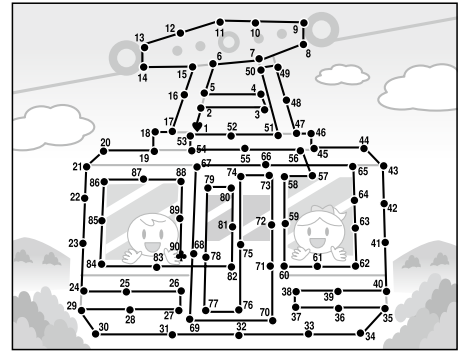

Q217 答え

B ブルドーザー

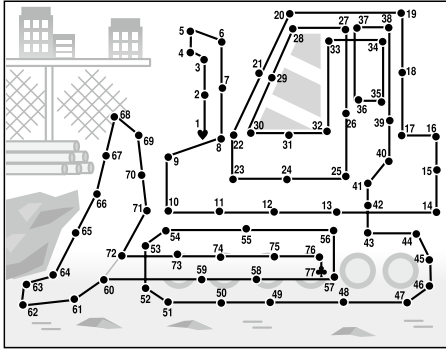

Q218 答え

C スーパーカー

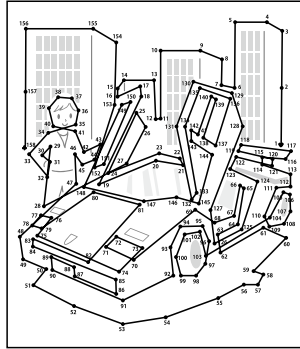

初級てんつなぎ

221 (バスケットボール)

Q219 答え

マラソン

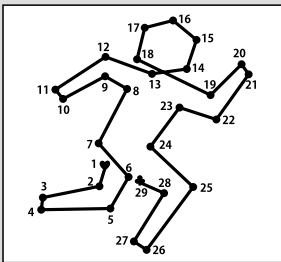

Q220 答え

アーチェリー

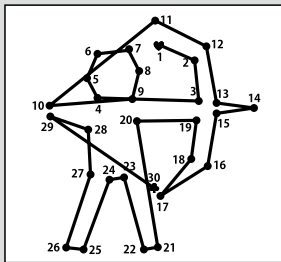

Q221 答え

バスケットボール

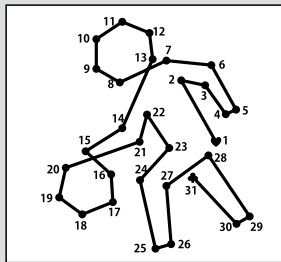

Q222 答え

重量挙げ

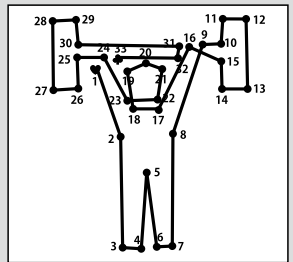

Q223 答え

C フォンダンショコラ

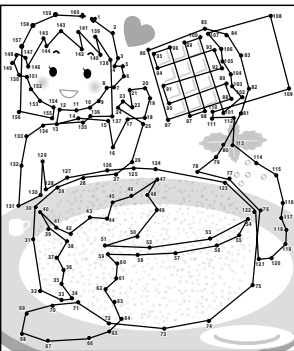

Q224 答え

C クマノミ

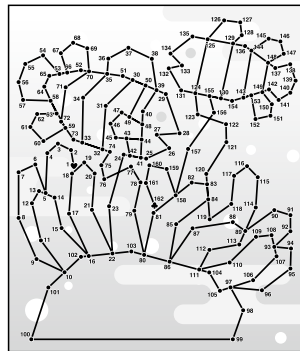

Q225 答え

A 野球

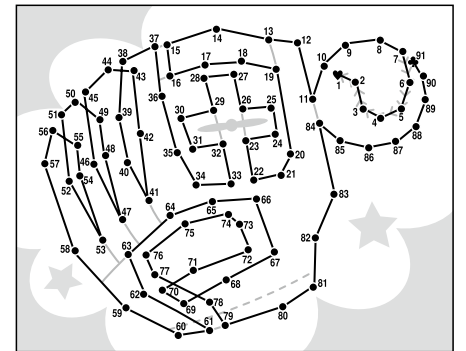

Q226 答え

B ボクシング

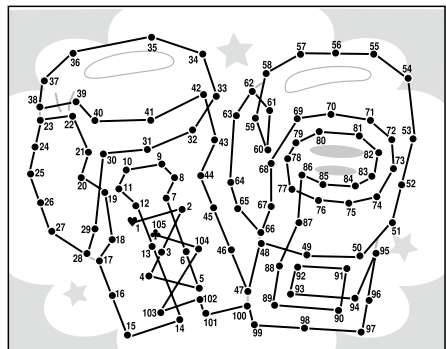

Q227 答え

A 忍者

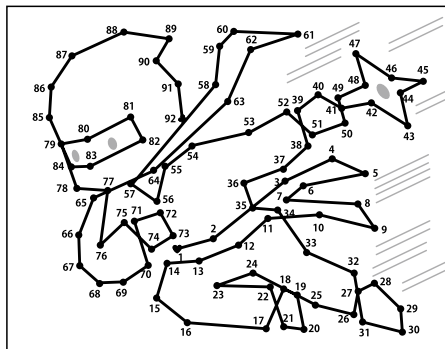

Q228 答え

C 稲刈り

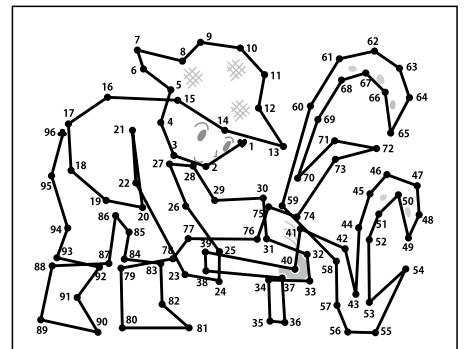

Q229 答え C Y字バランス

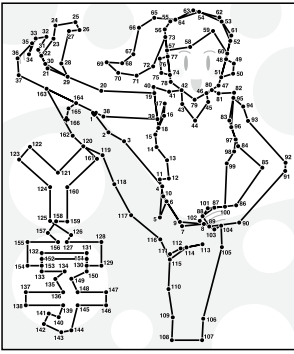

初級てんつなぎ②③

231 (シーソー)

Q230 答え ブランコ

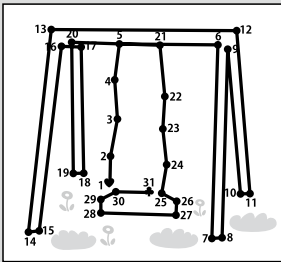

Q231 答え シーソー

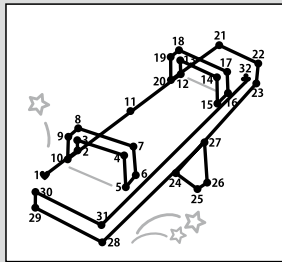

Q232 答え 鉄棒

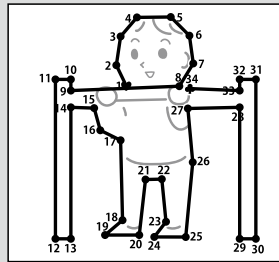

Q233 答え 滑り台

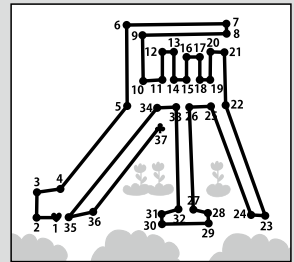

Q234 答え C 花火

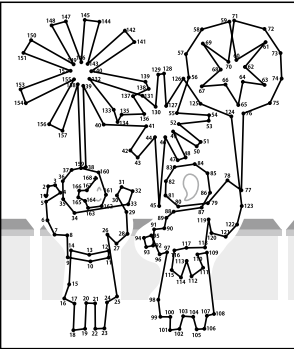

初級てんつなぎ②④

237 (サグラダ・ファミリア)

Q235 答え 凱旋門

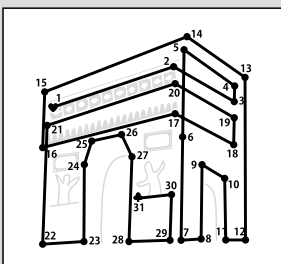

Q236 答え 自由の女神像

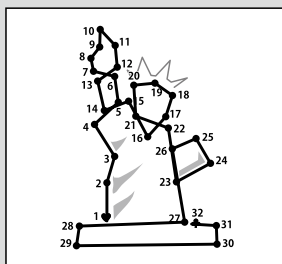

Q237 答え サグラダ・ファミリア

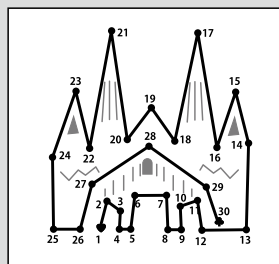

Q238 答え タージマハル

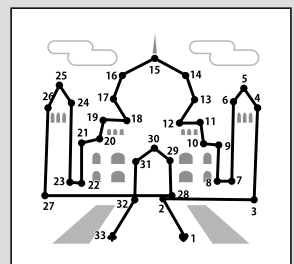

初級てんつなぎ②⑤

239 (リコーダー)

Q239 答え リコーダー

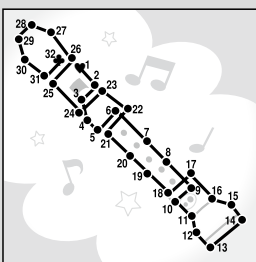

Q240 答え タンバリン

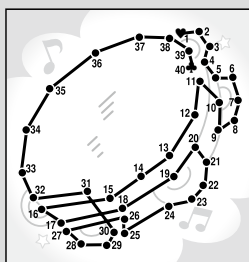

Q241 答え カスタネット

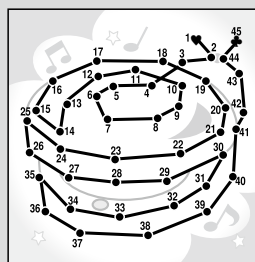

Q242 答え マラカス

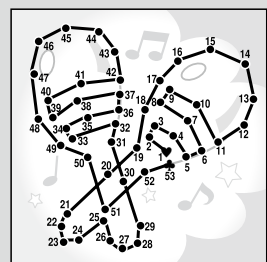

Q243 答え

B 授業中

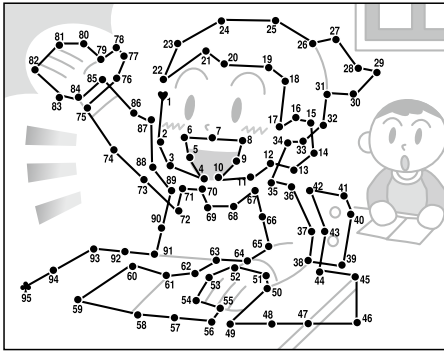

Q244 答え

A 重量挙げ

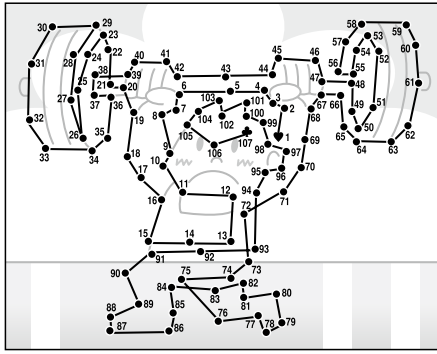

Q245 答え

E ボウリング

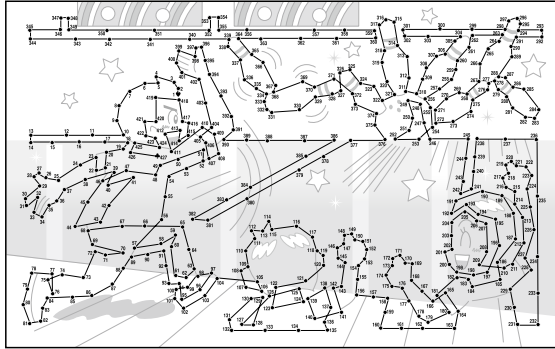

Q246 答え

C 流れ星

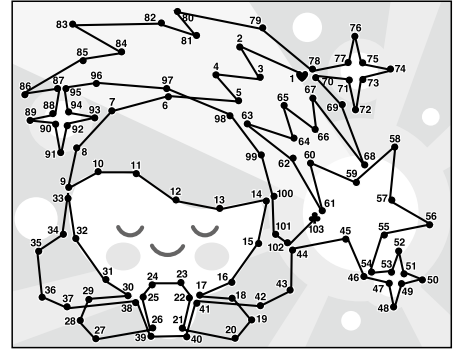

Q247 答え

A 牛乳

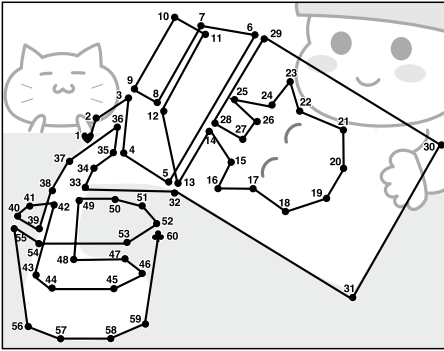

Q248 答え

B 3本

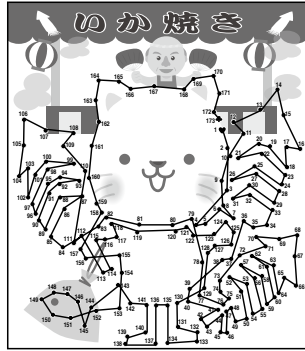

Q249 答え

B 子馬

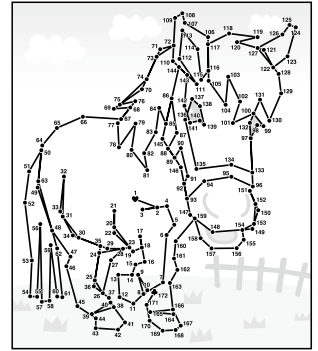

Q250 答え

C 射手座

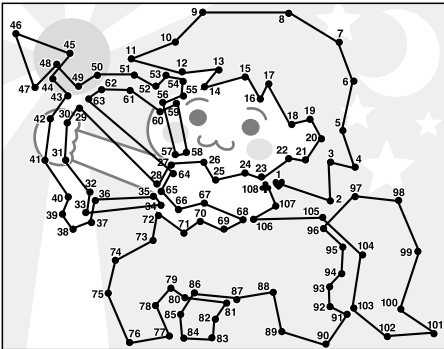

Q251 答え

A 山羊座

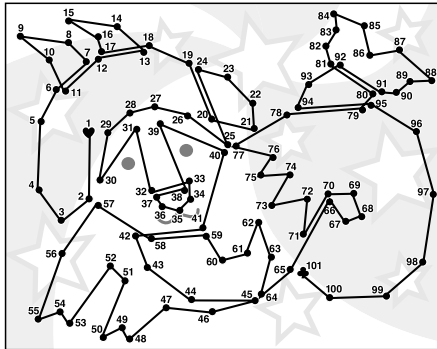

Q252 答え

C キッチンカー

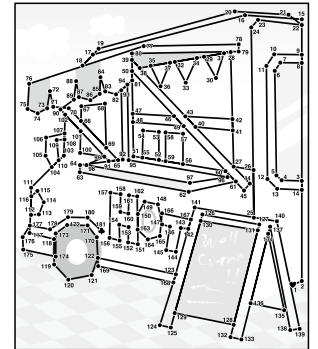

Q253 答え

B 映画監督

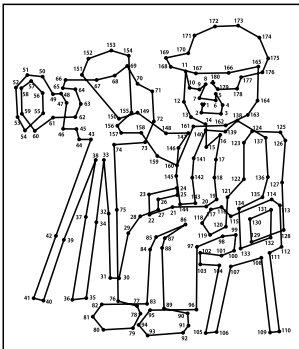

Q254 答え

A スペースシャトル

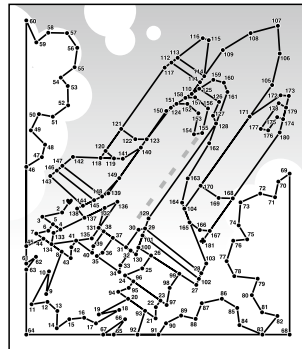

Q255 答え

A 小鬼

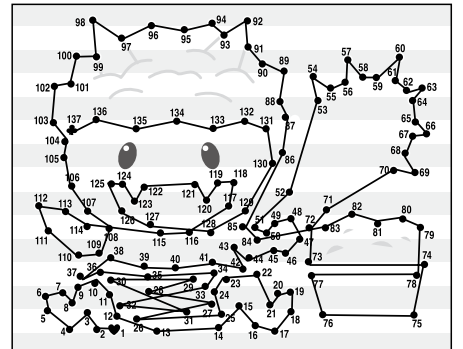

Q256 答え

B 孔雀

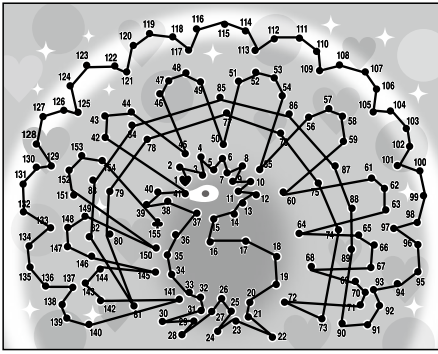

Q257 答え

A ケーキ

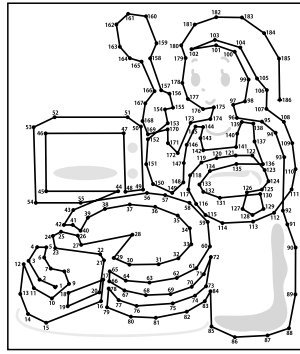

Q258 答え

B 神輿

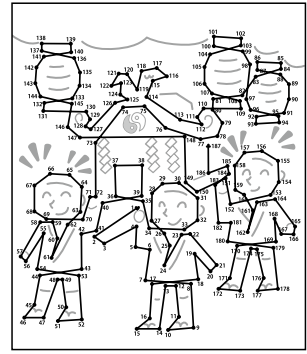

Q259 答え

B 競輪選手

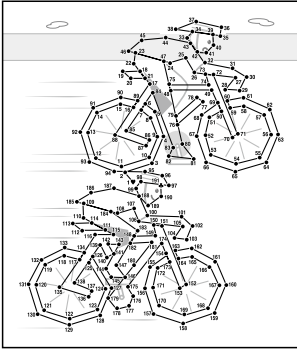

初級てんつなぎ②⑥

263 (ヤカン)

Q260 答え コーヒーカップ

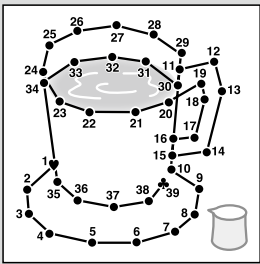

Q261 答え 湯呑

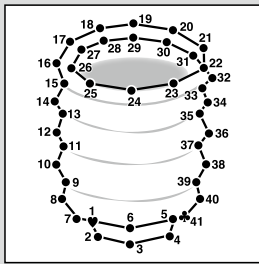

Q262 答え ポット

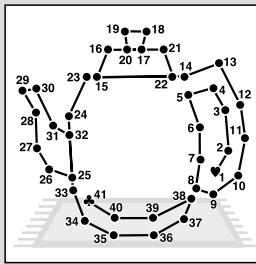

Q263 答え ヤカン

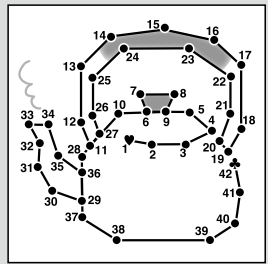

Q264 答え

A 大きな魚

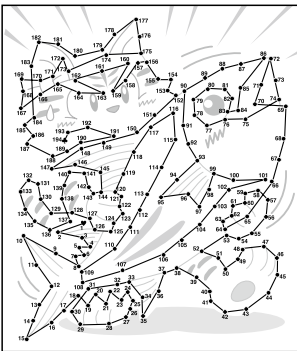

Q265 答え

B 電話

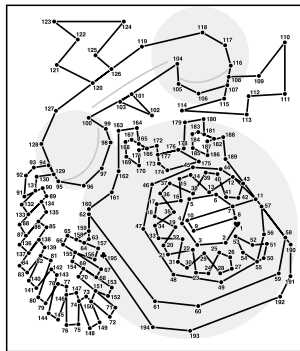

Q266 答え

C 吊り橋

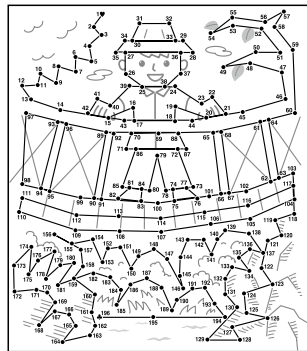

初級てんつなぎ⑦

268 (地図記号「発電所」)

Q267 答え 温泉

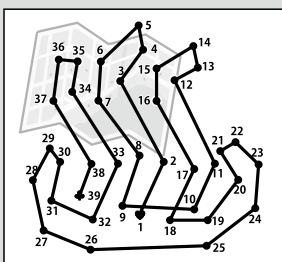

Q268 答え 発電所

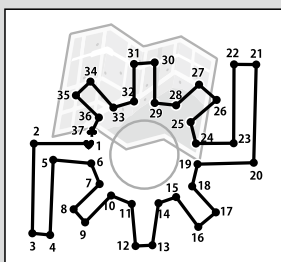

Q269 答え 老人ホーム

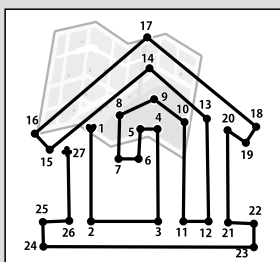

Q270 答え 博物館

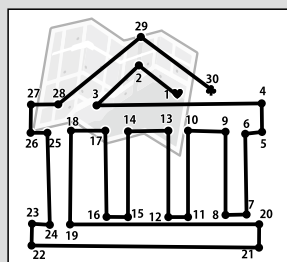

Q271 答え

B 眠り姫

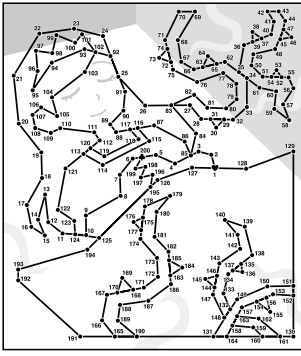

Q272 答え

B 西の市

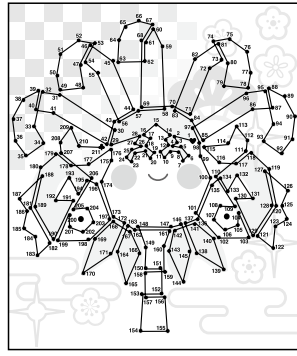

Q273 答え

C 涅槃仏

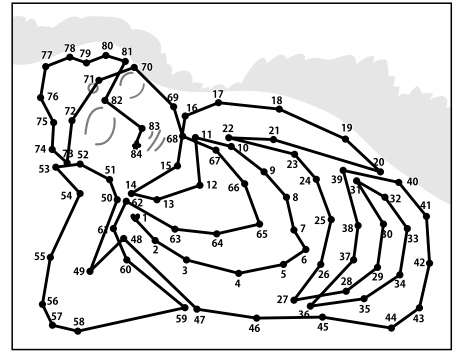

Q274 答え

A ツチノコ

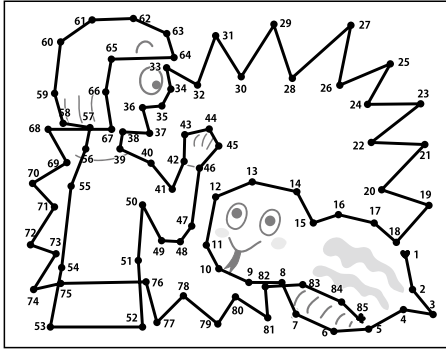

Q275 答え

A いも掘り

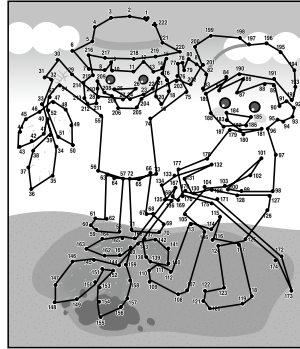

Q276 答え

A 左上のコマ

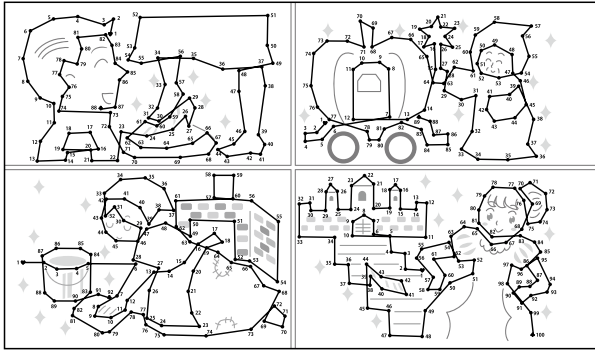

Q277 答え

A バンジージャンプ

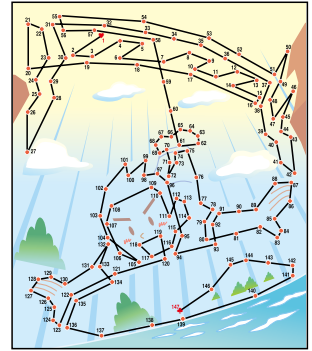

Q278 答え

A 歌舞伎

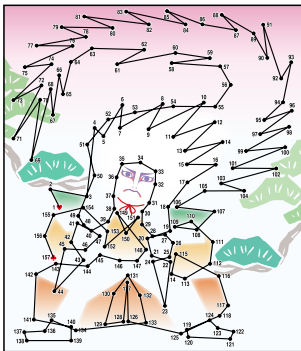

Q279 答え

A 孫悟空

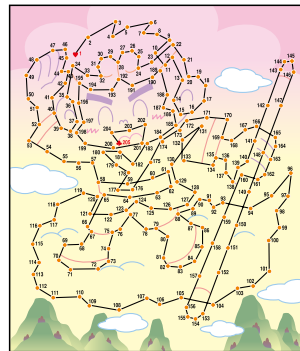

Q280 答え

B ラッコ

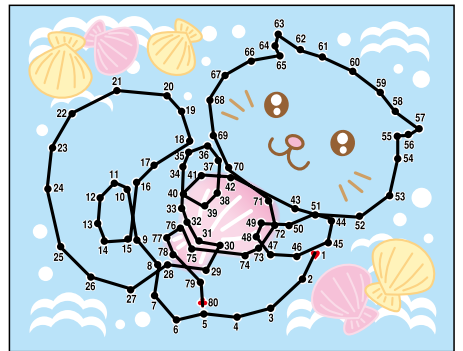

Q281 答え

A 焼き魚

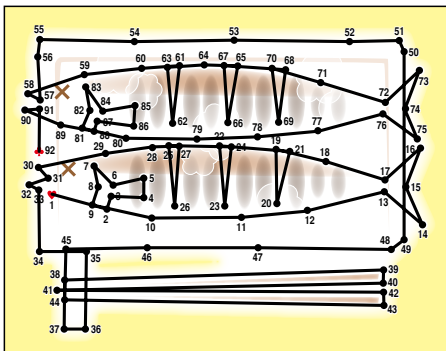

Q282 答え

C スベリ台

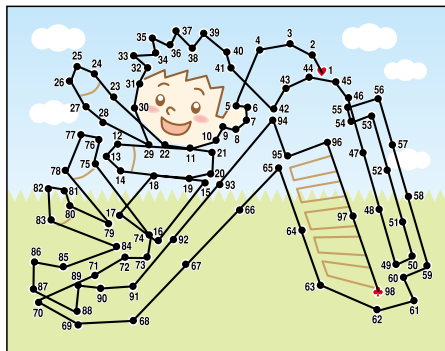

Q283 答え

C フクロウ

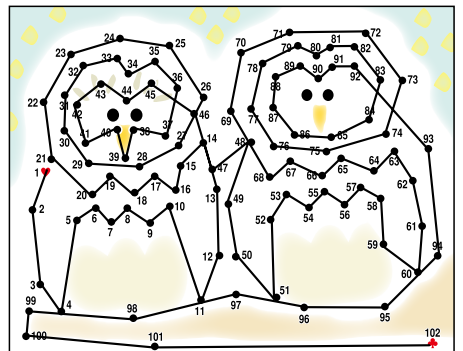

Q284 答え

E 大相撲

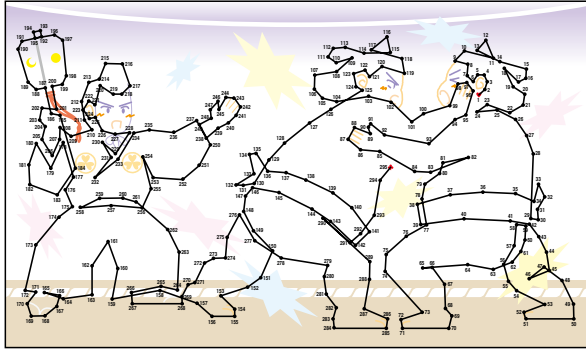

Q285 答え

B ぶた

